

technical. Handbook

SIMONA® Plastics

GLOBAL THERMOPLASTIC SOLUTIONS

Edelstahleinbauten
Einbau und Abdichtung
bauseitig

262,43

300

8150
SPRIT

2283

8150
SPRIT

300

Zwischenboden
rutschhemmende
PE-Platte (t=15)

Pumpensumpf Ø31
mit PP-H Abdeckung

8150
SPRIT

Ø1510

B

45°

Übergangsplatte

Zweiholm-Einstiegshilfe;
PE-Aufdopplung im Bereich
der Halter

Plastic is possibly one of the most versatile and important materials of the 20th and 21st century – an integral part of life as we currently know it. Today, plastics are capable of solving problems in many different fields of application ranging from industry and technology to automotive engineering, consumer goods and medical devices.

Contents

1	Preface	7	3.14	Polycarbonate (PC)	25
2	Chemical fundamentals of plastics	8	4	Material specifications	27
2.1	Thermoplastics	8	4.1	PE	28
2.1.1	Amorphous thermoplastics without side groups	11	4.2	PP	30
2.1.2	Amorphous thermoplastics with side groups	12	4.3	Rigid PVC	31
2.1.3	Partially crystalline thermoplastics	12	4.4	Foamed PVC	32
2.1.4	Summary of thermoplastics	13	4.5	PETG, PVDF, ECTFE, PFA	33
2.2	Thermoset plastics	14	5	Physical properties	34
2.2.1	Unsaturated polyester resins (UP)	14	5.1	Mechanical properties	34
2.2.2	Epoxy resins (EP)	15	5.1.1	Mechanical properties of thermoplastics	38
2.2.3	Phenacrylic resins (PHA) or vinyl ester resins (VE)	15	5.1.2	Tensile test	39
2.2.4	Phenolic resins (PF)	16	5.1.3	Bending test	41
2.3	Elastomers	16	5.1.4	Pressure test	43
3	General description of SIMONA® thermoplastics	17	5.1.5	Torsion pendulum test	43
3.1	Polyethylene (PE)	17	5.1.6	Ring shear test and segment shear test	44
3.2	Polypropylene homopolymer (PP-H)	18	5.1.7	Pull-off test	45
3.2.1	Isotactic polypropylene	18	5.1.8	Testing notched impact strength	46
3.2.2	Syndiotactic polypropylene	18	5.1.9	Testing impact strength	46
3.2.3	Atactic polypropylene	19	5.1.10	Surface hardness	48
3.3	Polypropylene copolymer (PP-C)	19	5.1.10.1	Ball indentation hardness H as per DIN EN ISO 2039-1	48
3.4	Polyvinyl chloride (PVC-U)	20	5.1.10.2	Shore D hardness as per DIN EN ISO 868	48
3.5	Post-chlorinated polyvinyl chloride (CPVC)	21	5.1.11	Wear properties	48
3.6	Polyvinylidene fluoride (PVDF)	21	5.1.11.1	Sand-slurry test	50
3.7	Ethylene chlorotrifluoroethylene (ECTFE)	22	5.2	Thermal properties	51
3.8	Ethylene tetrafluoroethylene (ETFE)	22	5.2.1	Thermal conduction	51
3.9	Perfluoroalkoxy copolymer (PFA)	23	5.2.1.1	Heat capacity	52
3.10	Glycol-modified polyethylene terephthalate (PETG)	24	5.2.1.2	Thermal conductivity	52
3.11	Polylactic acid (PLA)	24	5.2.2	Heat transfer	52
3.12	Polyamides (PA)	25	5.2.3	Thermal expansion	53
3.13	Polymethyl methacrylate (PMMA)	25	5.2.4	Heat distortion temperature test	55
			5.3	Fire rating	55
			5.3.1	Fire test as per DIN 4102	55
			5.3.2	SBI test as per DIN EN 13823	57

5.3.3	Fire test as per FM 4910	58
5.3.4	Fire tests as per UL 94	59
5.4	Permeation	60
5.5	Water absorption	61
5.6	Electrical properties	62
5.6.1	Electrical conductivity	62
5.6.2	Dielectric properties	62
5.6.3	Dielectric strength Ed in accordance with DIN 53481 / VDE 0303-1	63
5.6.4	Electric tracking resistance in accordance with DIN 53480 / VDE 0303-1	64
5.6.5	Static	64
6	Chemical properties	65
7	Other properties	67
7.1	Physiological safety	67
7.1.1	Contact with food according to European Directives	67
7.1.2	Contact with drinking water	68
7.2	Radiation resistance	69
8	Long-term properties	70
8.1	Test methods	70
8.1.1	Tensile creep test	70
8.1.2	Internal pressure creep rupture strength test	70
8.1.3	Full notch creep test (FNCT)	71
8.1.4	Creep curves	71
8.1.5	Isochronous stress-strain diagrams	74
8.2	Structural analyses	75
8.3	Materials in tank construction requiring mandatory test certificates	76

9	Plastic physics	77
9.1	Stress types	77
9.2	Reduction of inherent stresses	79
9.3	Heat stresses	80
9.4	Influence of orientations on the properties of plastics	84
9.5	Shrinkage	84
9.6	Contraction	84
9.7	Influences on component strength	85
9.7.1	Notch effect	85
9.7.2	Welding thermoplastics	86
9.7.2.1	Weldability of material types	86
9.7.2.2	Welding methods	87
9.7.2.3	Structural strength	87
9.7.2.4	Position of weld seams	88
9.8	Stresses	89
9.9	Stress cracking	92
9.9.1	Inherent stresses	93
9.10	Calculation of permissible cold-bending radii	94
9.11	Ageing	95
9.11.1	Ageing processes due to light	95
9.11.1.1	Photolysis	95
9.11.1.2	Photo-oxidation	96
9.11.2	Other ageing processes	96
9.11.3	Ageing tests	96
10	Legal note and advice	99
11	List of illustrations, tables and literature	100

1 Preface

Plastic – a word with highly emotive and contradictory connotations: On the one hand, it is seen as one of the negative aspects of modern civilisation, particularly against the backdrop of public debate concerning the environment („marine littering“ being a case in point). On the other hand, however, plastic is possibly one of the most versatile and important materials of the 20th and 21st century – an integral part of life as we currently know it. Today, plastics are capable of solving problems in many different fields of application ranging from industry and technology to automotive engineering, consumer goods and medical devices. The origins of plastic, a substance that is synthetic as opposed to being produced naturally, stretch far back to the beginning of the 19th century. Whether natural rubber or derivatives produced from cellulose („celluloid“), the 19th century heralded the dawn of early „bioplastics“ (now becoming increasingly prominent thanks to intense marketing in response to current concerns over the environment and debate centred around sustainability). This was followed by other mass-market plastics that are still in use today – manufactured with the help of petrochemicals. PVC, for example, was developed in a laboratory in the mid-1920s and first saw the light of day (at an industrial level) in around 1930. The first PVC pipes date back to this period. The mid-1940s saw the birth of polyethylene and polypropylene. The first industrial goods made of these plastics were launched in the 1950s. In industrial terms, this decade also marked the beginning for fluorinated plastics such as Teflon (PTFE). The plastics boom reached its peak after the Second World War, contributing significantly to the buoyant era of post-war industrialisation. In actual fact, however, the development of specialist plastics is far from over. Likewise, there are many fields of application that have yet to be unlocked. New groups of material are being engineered and prepared for mass production in particular within the area of specialty or functionalised components.

As a manufacturer of thermoplastic products such as semi-finished parts, pipes and fittings as well as finished parts and components for various assemblies, SIMONA AG is equally committed to identifying new products and fields of application.

SIMONA AG was established by the Simon brothers as a leather producer in as early as 1857. Our history as a company reflects the direction taken by industrial society as a whole. Against the backdrop of changing economic conditions and technical innovation, our company's product range was transformed almost completely. Over the decades, SIMONA saw the transition from leather to premium-quality semi-finished plastics – i.e. from a natural product to a product based on synthetic polymers manufactured at an industrial level.

The success of this „paradigm shift“ within the company is a testament to our pioneering efforts in the field of semi-finished plastics and our commitment to developing and evolving specific areas of application in close collaboration with our customers. We have excelled not only as a result of our significant expertise surrounding the materials and processes used but also due to our in-depth knowledge of the individual fields of application and the interactions of various materials within these specific areas.

This book brings together our expertise in the field of materials and applications. It has been compiled with our customers in mind, i.e. for those people who, like SIMONA, have a keen interest in plastic as one of the most versatile materials imaginable – for people who share our passion and are inspired by the many areas of application that plastics can unlock. It is to be seen as a reference book, training manual and source for new ideas. With this in mind, we hope you enjoy reading this book and look forward to any comments you might have.

SIMONA AG
Technical Service Centre/Applications Engineering

2 Chemical fundamentals of plastics

In nature there are numerous biopolymers but the plastics commonly used nowadays are polymers that are synthetically manufactured from oil, natural gas and coal or by conversion of natural products (e.g. sugar, etc.). They are defined as organic compounds that are made up of macromolecules with a molecular mass of $> 10^4$ u ($1 \text{ u} = 1/12$ of the mass of ^{12}C). Macromolecules are made up of individual units, monomers. Macromolecules are also described as oligomers and polymers; they have different molar masses and chain lengths:

Oligomers = 1.000 – 10.000

Polymers = > 10.000

The above definition is so general that even many natural materials would be classified as plastics. They include wood, leather, cotton, wool, hemp, silk, etc., some of which have been used as materials since time immemorial. It is also necessary to distinguish between biological polymers and synthetic polymers. Most polymers are based on polysaccharides, i.e. sugars containing many carbohydrate units, whereas synthetic plastics are largely based on the ability of the carbon atom to form homopolar bonds (atomic bonds). This type of bond can have a high degree of stability, as demonstrated in a diamond, for example, in which only carbon atoms are arranged in a lattice. Plastics generally consist of carbon and hydrogen; it is also possible to replace these elements with others such as oxygen, nitrogen, halogens or even carbon.

As already mentioned above, systematic classification of plastics is based on the monomers of which they are composed. In addition, it is also possible to divide the various plastics into the following groups, depending on their temperature-dependent mechanical properties: thermoplastics, elastomers and thermoset plastics.

2.1 Thermoplastics

Thermoplastics consist of long polymers that are linked with one another by so-called „van der Waals bonds“. These purely physical bonds are based on the interaction of electric dipoles, just as opposite magnetic poles attract each other and like poles repel each other. The strength, or to be more precise, the energy of the bond depends on the polarity of the macromolecules in this case. Generally speaking, these interactions are termed dispersion forces, which are divided up into London forces, Debye forces and Keesom forces and the bond energy of which increases in that order. Bond energy W is inversely proportional to the sixth power of the distance r of the molecules in relation to one another:

$$W \sim r^{-6}.$$

The van der Waals forces are a special class of Keesom forces. The hydrogen bridge bond in turn is categorised as a van der Waals force. In terms of quality, bond energy can be characterised by melting point, tensile strength or modulus of elasticity; the latter, however, has to be within the elastic energy range. Since the bond is purely physical, the individual macromolecules can, provided the supply of heat is sufficient, shear off one another without the bond being destroyed. The thermoplastic softens and melts at relatively high temperatures. This purely physical process is reversible so this property makes it possible to weld thermoplastics to one another. In a welded seam the mechanical and chemical properties achieved are virtually identical to those of the substrate. However, the welding process is subject to slight degradation mechanisms, although judging from many years of experience they do not have any negative impact on stability.

Thermoplastics are divided up into amorphous ones and partially crystalline ones. Amorphous thermoplastics have a microstructure in which the molecular chains are distributed in a virtually random (amorphous) manner (Figure 1).

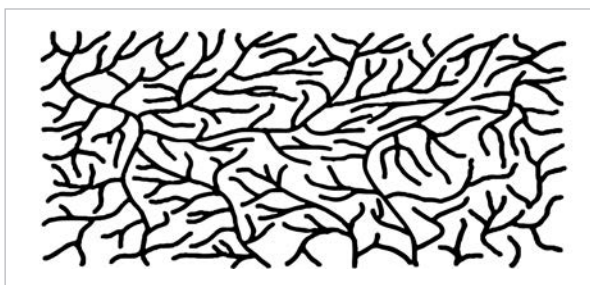

Figure 1: Structural model of an amorphous thermoplastic

Partially crystalline thermoplastics, on the other hand, have regions in which the molecular chains are parallel (crystalline regions) (Figure 2). These regions, in turn, separate amorphous areas. Thermoplastics usually crystallise to such an extent that the crystallites are arranged in superstructures called spherulites. Such crystallites have a higher density and order than amorphous regions. As crystallinity increases, transparency decreases. The plastic becomes translucent (opaque, translucent).

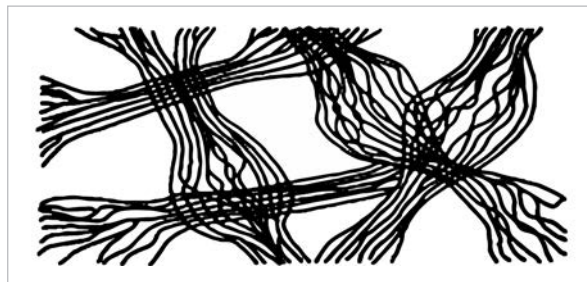

Figure 2: Structural model of a partially crystalline thermoplastic

In industry, a very wide variety of thermoplastics are used, depending on the application. The following table (Table 1) is designed to provide an overview of the most important thermoplastics and their monomers.



Plastic	Monomer	Monomer formula
Polyethylene (PE)	Ethylene	$\text{H}_2\text{C}=\text{CH}_2$
Polypropylene (PP)	Propylene	$\text{H}_2\text{C}=\text{CHCH}_3$
Polyvinylidene chloride (PVDC)	Vinylidene chloride	$\text{H}_2\text{C}=\text{CCl}_2$
Polyvinylidene fluoride (PVDF)	Vinylidene fluoride	$\text{H}_2\text{C}=\text{CF}_2$
Polyvinyl chloride (PVC)	Vinyl chloride	$\text{H}_2\text{C}=\text{CHCl}$
Glycol-modified polyethylene terephthalate (PETG)	Terephthalic acid and ethylene glycol	
Polystyrene (PS)	Styrene	
Ethylene chlorotrifluoroethylene (ECTFE)	Ethylene and chlorotrifluoroethylene	$\text{H}_2\text{C}=\text{CH}_2$ 
Ethylene tetrafluoroethylene (ETFE)	Ethylene and tetrafluoroethylene (TFE)	$\text{H}_2\text{C}=\text{CH}_2$ 
Perfluoroalkoxy polymers (PFA)	Copolymer consisting of TFE and perfluoroalkoxy vinyl ether	 $\text{R} = \text{C}_n\text{F}_{2n+1}$
Polyamide 6 (PA6 - „Perlon“) or polyamide 6.6 (PA6.6 - „Nylon“)	ϵ -Caprolactam or hexa-methylenediamine (HMD) and adipic acid (as hexamethylene diamine adipate)	
Polylactide (PLA)	Lactic acid anhydride	
Polymethyl methacrylate (PMMA, also known as „acrylic glass“ or „Plexiglas“)	Methacrylic methyl esters (MMA)	
Polycarbonate (PC, also known as „Makrolon“)	Bisphenol A and phosgene	

Table 1: Selection of thermoplastics and the (possible) associated monomers

Alkenes with the molecular formula C_nH_{2n} are also referred to as olefins and the macromolecules formed from them are termed polyolefins. In Table 1 only polyethylene and polypropylene are classified as polyolefins.

The monomers listed in Table 1 react with one another by breaking up the double bond so that the carbon atoms which were previously linked to one another by a double bond each form a free valence (bond) to which more monomers can attach. This process is also referred to as polymerisation and the resulting macromolecules are termed polymers.

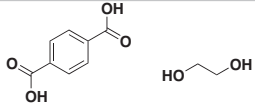
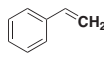
On account of this reaction mechanism it is understandable that the monomers usually form unbranched macromolecules, which in a union can be arranged in a regular or random manner owing to the different physical interactions. If the chain is regular, i.e. if the molecules are arranged in parallel, this is referred to as crystallinity. In many instances it is not the case throughout the entire workpiece so the material is referred to as partially crystalline. The amount of crystallinity is heavily influenced by the incorporation of side chains or side molecules. In such cases the result is often a partially crystalline thermoplastic. In addition, crystallisation can be completely prevented by incorporating foreign monomers into the chain (copolymerisation). One example of this is the copolymer EPDM made up of ethylene and propylene, which solidifies amorphously (in a non-crystalline manner) by incorporating 30% propylene.

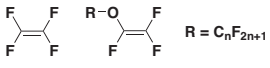
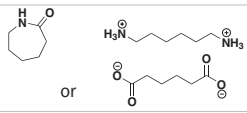
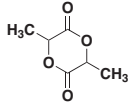
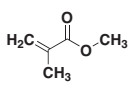
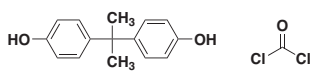
In industrial engineering the above thermoplastics are also modified by the manufacturing process and combination with foreign monomers and plasticizers.

Polyethylene exists, for example, as PE-LD (Low Density), PE-HD (High Density) and PE-UHMW (Ultra High Molecular Weight).

PE-LD is manufactured in a high-pressure process at 1,000 – 3,000 bar and at temperatures of 150 – 300°C. In this case, highly branched chains are formed.

PE-HD is manufactured in a medium pressure process by means of solvent polymerisation in xylene at 150 – 180°C and at a pressure of about 35 bar, forming largely linear chains.

PE-UHMW is manufactured in a low-pressure process using Ziegler catalysts at 20 – 150°C and 2 – 50 bar, creating virtually unbranched linear chains.

2.1.1 Amorphous thermoplastics without side groups

Amorphous thermoplastics consist of random molecular chains as the spatial structure. This microstructure has a crucial impact on the properties of the material. Among other aspects, the material is transparent and when it is subjected to thermal processing there is less shrinkage and contraction than with a partially crystalline material, owing to the absence of (secondary) crystallisation. An amorphous thermoplastic (Figure 1) is used below the glass transition temperature T_g . Here the material behaves in a linearly elastic manner. If the temperature continues to drop, the thermoplastic reacts and becomes sensitive to impact. Above T_g the amorphous thermoplastic begins to flow substantially and loses its service properties.

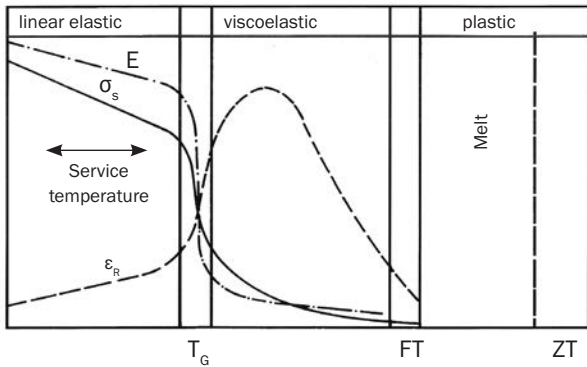

Figure 3: Mechanical properties of amorphous thermoplastics

- E = Modulus of elasticity
- T_G = Glass transition temperature
- σ_s = Yield stress
- ϵ_R = Elongation at break
- FT = Flow temperature range
- ZT = Decomposition temperature range

For PVC-U the service temperature is between 0 °C and 60 °C. Processing, such as forming for example, usually takes place above T_G . In the temperature range above the flow temperature range the thermoplastic starts to melt. This temperature range is used for welding.

Typical amorphous thermoplastics in the SIMONA® range of semi-finished products:

- SIMONA® PVC-CAW
- SIMOPOR-LIGHT/-ULTRALIGHT
- SIMONA® COPLAST-AS/-AS-X
- SIMONA® PVC-GLAS
- SIMOLUX

2.1.2 Amorphous thermoplastics with side groups

This group of materials, as opposed to the previous one, is in the vitreous state even at very low temperatures. Owing to the molecular structure or the addition of appropriate additives, there are two successive ranges above the glass transition temperature in which these materials can be exposed to different applications.

1. Secondary relaxation range:

The side groups become mobile and the materials thus become tougher. This is the actual service temperature range. Mechanical properties only change slightly.

2. Primary relaxation range:

Amorphous areas soften and the material changes to the thermoplastic state.

Typical materials in the SIMONA® range of semi-finished products are the more impact-resistant materials:

- SIMONA® PVC-MZ-COLOR
- SIMONA® PVC-GLAS-SX

2.1.3 Partially crystalline thermoplastics

In terms of structure, partially crystalline materials have partially parallel molecular chains (crystalline areas) and ones with a three-dimensional felt structure (amorphous areas) (Figure 2). These completely opposite structures lead to different types of behaviour at changing temperatures, so with this material as well the terms primary and secondary relaxation range are justified. As opposed to amorphous thermoplastics with side groups or copolymers (polymerisation of different monomers to achieve

certain properties), the service temperature is between the primary and secondary relaxation ranges. At very low temperatures (in the vitreous state) partially crystalline thermoplastics are brittle and hence sensitive to impact. In the secondary relaxation range, on the other hand, the amorphous components soften so the material becomes resilient in the service temperature range. The advantages of this material result from its toughness due to softened amorphous components and the existing rigidity and hardness on account of frozen crystalline components.

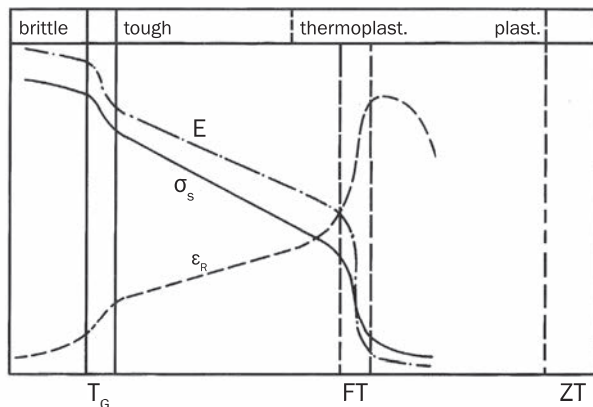

Figure 4: Mechanical properties of partially crystalline thermoplastics

E = Modulus of elasticity

T_G = Glass transition temperature

σ_s = Yield stress

ϵ_R = Elongation at break

FT = Flow temperature range

ZT = Decomposition temperature range

In the primary relaxation range, the crystalline melting range, the crystalline components also soften. As temperature rises, the material changes to the molten state and becomes plastic.

Typical materials in the SIMONA® range of semi-finished products:

- SIMONA® PE-HD
- SIMONA® PE 100
- SIMONA® PP-H AlphaPlus® / SIMONA® PP-H natural
- SIMONA® PVDF
- SIMONA® ECTFE

2.1.4 Summary of thermoplastics

As is evident from the previous chapters, the molecular arrangement has a considerable influence on the fundamental properties of the particular group of materials. Here is a comparison of the main characteristic features:

Amorphous thermoplastics have

- higher strength
- higher rigidity
- higher surface hardness
- higher surface quality
- less thermal expansion
- less distortion tendency

Partially crystalline materials, on the other hand, have

- higher expansibility
- higher impact strength

It should be noted that the properties and behaviour of plastics, including thermoplastics, are heavily influenced by the additives used. In this respect the abovementioned properties should be regarded as neutral because their assessment depends on the particular application and product. The following chapters aim to provide further information on this.

2.2 Thermoset plastics

Thermoset plastics are made from low-molecular-weight reaction resins that irreversibly react with one another chemically to create a three-dimensional network when chemical compounds (hardeners) are added or heat, pressure or light energy is applied (Figure 5).

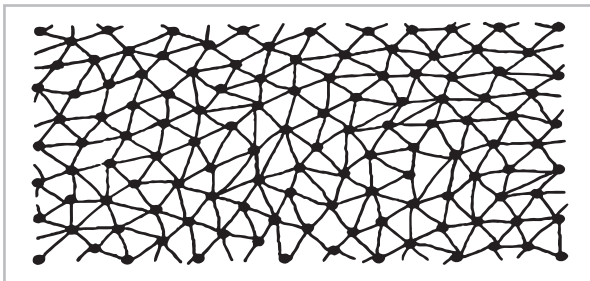

Figure 5: Structural model of a thermoset plastic

This reaction is also termed cross-linking reaction. The starting materials used are normally linear, low-molecular-weight reaction resins that contain additional reactive groups or double bonds and can thus continue to react (cross-link).

Owing to the chemical bonds in the cross-linked thermoset plastics, they cannot melt, as opposed to thermoplastic materials, nor can they be welded to one another. Therefore, they are used in a very wide range of industrial sectors.

Thermoset plastics are classified, inter alia, as unsaturated polyester resins, epoxy resins, phenacrylic resins, phenolic resins, furan resins and melamine resins.

2.2.1 Unsaturated polyester resins (UP)

Unsaturated polyester resins are usually formed by melt condensation from unsaturated bifunctional or polyfunctional carboxylic acids or their anhydrides, saturated dicarboxylic acids and dialcohols. The double bonds of unsaturated carboxylic acids remain in the condensed resins as reactive sites for subsequent cross-linking. The saturated acid compounds regulate chain length, reactivity as well as the physical and chemical properties of the thermoset plastic. The name polyester refers to the ester groups in the macromolecules.

Various acids and dialcohols are of special technological interest. The selection of individual components depends to a large extent on the required mechanical and chemical properties of the hardened polyester. For the various components, please refer to the literature [2].

The names of the various polyesters often include the name of the glycol and/or that of the carboxylic acid. There are ophthalic acid polyesters, bisphenol A polyesters or also terephthalic acid polyesters, to give just a few examples.

Polyesters are usually either viscous or solid, so for further processing they are dissolved in solvents (e.g. styrene) that also contain a double bond. Linear polyester chains are then cross-linked with one another via monomers, which also serve as solvents for those resins. When selecting monomers, care must be taken to ensure that the polyester is readily soluble in it and the rate

of self-polymerisation of the reactive solvent (reactive diluent) is lower than that of copolymerisation with the UP resin. The solvent that is most important from a technological aspect is styrene.

However, other reactive diluents can be used such as methyl methacrylate, diallyl phthalate or triallyl cyanurate, although these do then bring about different properties in the polyester mixture and the hardened polyester.

Polymerisation of unsaturated polyesters is triggered by radicals that are supplied by organic peroxides. Peroxides decompose in heat or they are catalysed by accelerators, even at room temperature, to form radicals that open the existing double bonds of the reactive diluent and the polyester. In industry the hardener often used is methyl ethyl ketone peroxide (MEKP).

The energy released in the reaction, which takes the form of heat, promotes the formation of radicals. The resulting temperature can be above 200 °C and in extreme cases it can even destroy the polyester if the reaction heat is not dissipated quickly enough.

2.2.2 Epoxy resins (EP)

Epoxy resins are made up of epoxides with functional groups and compounds which, owing to the catalytic release of hydrogen (actively) to the epoxide group, bind to the epoxide in an addition reaction (Figure 6).

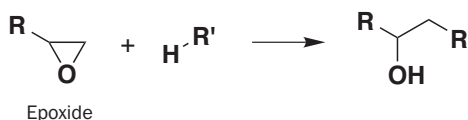

Figure 6: Addition reaction of an epoxide

The hardening of an epoxy resin is a polyaddition reaction. Here, polymerisation of the epoxide groups is of minor importance. Hardeners used are carboxylic acid anhydrides and polyamines. Hardeners are usually incorporated into the finished product so the dosage of hardener is in an equimolar ratio regarding the reactive groups of resin and hardener [2].

Since epoxy resins are often highly viscous, reactive diluents, which themselves possess epoxide groups and can thus participate in the cross-linking reaction, are added to improve processing. Consequently, the properties of an epoxy resin are substantially influenced by the hardener and reactive diluent used.

2.2.3 Phenacrylic resins (PHA) or vinyl ester resins (VE)

Vinyl ester resins are formed from an epoxy resin and an unsaturated organic acid. Nowadays they are termed phenacrylic resins.

In contrast to UP resins, the reactive double bonds are only located at the ends of the molecule. Consequently, a rapid and complete reaction usually takes place with the copolymers during the hardening process. Therefore, chemical attack by hydrolysis, or by opening of remaining C=C double bonds due to oxidation or halogenation, is of minor importance. For this reason, cured vinyl ester resins are more resistant to chemical attack than unsaturated polyester resins or epoxy resins.

Another advantage is attributable to the secondary hydroxyl groups in the vinyl ester resin, which can interact with siliceous fillers and glass, thus providing greater mechanical strength in bonds with glass fibres.

Vinyl ester resins with a higher heat deflection temperature are manufactured from epoxidated novolacs, acrylic acid and/or methacrylic acid [2].

As with unsaturated polyester resins, the monomer normally used for cross-linking is styrene, in which phenacrylic resin is dissolved. However, it is also possible to use other monomers with a double bond, as with UP resins. Hardening of the VE resins is performed by heat, peroxides or radiation, which leads to the formation of free radicals, in a similar way to that of UP resins. The peroxide often used is methyl ethyl ketone peroxide (MEKP) and the accelerators are cobalt octoate and amines such as dimethylaniline.

2.2.4 Phenolic resins (PF)

Phenolic resins, also known as phenolic plastics, are defined as synthetic resins that are formed by the condensation of phenols, phenol derivatives and aldehydes. Apart from phenol, important phenolic starting products are ortho-, meta- and paracresol (methyl phenol), xlenols, alkyl phenols, aryl phenols and resorcinol.

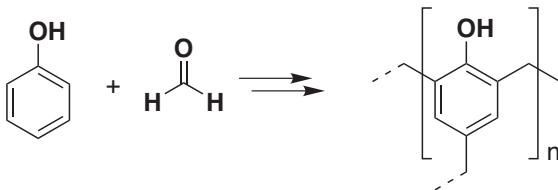

Figure 7: Synthesis scheme of a methylene phenol group as a structural element of a conventional phenolic resin consisting of phenol and formaldehyde

The aldehyde used by industry is formaldehyde or para-formaldehyde. Depending on the type of phenolic resin, hardening is performed in heat ($\geq 140^{\circ}\text{C}$) or by adding an acid or alkaline catalyst (cold setting).

2.3 Elastomers

As opposed to thermoset plastics, elastomers are only weakly cross-linked. They cannot be melted but can be stretched and elastically deformed at low temperatures. Elastomers, like natural rubber, silicone rubber and synthetic elastomers such as polyisobutylene, are used to make tyres and gaskets, for example.

The description below only covers thermoplastics.

3 General description of SIMONA® thermoplastics

3.1 Polyethylene (PE)

Of all the plastics, polyethylene has the simplest molecular structure due to its succession of CH₂ segments.

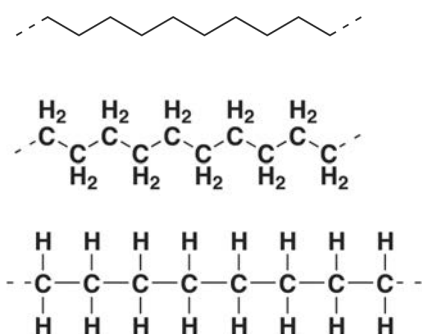

Figure 8: Various schematic representations of polyethylene

Depending on the production process, polyethylene can be manufactured with high or low density. The difference between the two is the number of branches (Figure 9 and Figure 10).



Figure 9: High-density PE

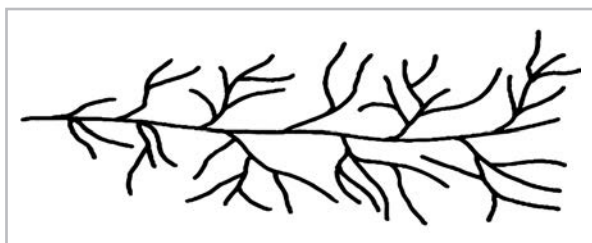

Figure 10: Low-density PE

These branches reflect the degree of crystallinity, i.e. the lower the number, the higher the crystallinity. At the same time, however, rising crystallinity means higher density and a higher crystalline melting range.

	Crystallinity %	Density g/cm ³	Melting range °C
PE-LD	40 - 50	0.92 - 0.94	130 - 145
PE-HD	60 - 80	0.95 - 0.97	130 - 145

Table 2: Specifications of PE

To assess the behaviour of different types of polyethylene, we use the chain length of a molecule with the resulting mean molecular weight *M* (sum of atomic weights of all the atoms contained in a molecule).

It should be pointed out that there are various methods of determining molecular weight (e.g. light scattering, osmosis, viscosity, mathematically according to Margolies). However, the various methods can result in different molar masses for the same material.

	<i>M</i> possible	<i>M</i> technically common
PE-LD	5,000 - 50,000	20,000 - 50,000
PE-HD	6,000 - 4,000,000	ca. 100,000
PE-HMW	500,000 - 1,000,000	500,000
PE-UHMW	> 1,000,000	Approx. 4,500,000 - 10,500,000

Table 3: Molecular weight in g/mol

M < 10,000 = wax-like

Explanation of abbreviations:

- LD = Low Density
- HD = High Density
- HMW = High Molecular Weight
- UHMW = Ultra High Molecular Weight

3.2.3 Atactic polypropylene

The CH₃ groups do not follow any rule regarding their position in relation to the main chain.

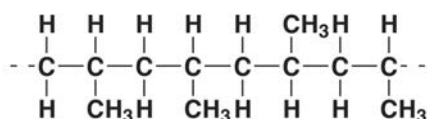

Figure 15: Diagram of atactic PP

For technical applications, isotactic PP must be regarded as the main type because as isotacticity rises, so too do the level of crystallinity, melting point, tensile strength, rigidity and hardness. That is why SIMONA® PP-H natural and PP-H AlphaPlus® semi-finished products are made of isotactic PP.

Compared to polyethylene, the properties of polypropylene vary, despite the molecular structure being similar:

- lower density (0.91 g/cm³)
- higher glass transition temperature
- higher melting point and hence higher dimensional stability under heat
- PP homopolymers at low temperatures are brittle whilst copolymers with ethylene are impact-resistant

The properties of polypropylene can be influenced by controlled crystallisation. PP homo-polymers chiefly crystallise in the form of alpha (α) spherulites (spherical crystals). The addition of nucleation agents enables a controlled, more uniform α-crystal structure or the formation of beta (β) spherulites whilst α-nucleated PP exhibits very good rigidity (high modulus of elasticity) even at high temperatures. By contrast, β-nucleated PP is more flexible and has a raised level of impact resistance.

SIMONA offers an α-nucleated PP as standard in the form of SIMONA® PP-H AlphaPlus®.

SIMONA® semi-plastic products made of PP are often used in chemical apparatus construction, mainly indoors, at temperatures between 0 °C and 100 °C. Especially in the upper temperature range a higher level of rigidity is desirable, which can be provided by using a homopolymer.

3.3 Polypropylene copolymer (PP-C)

For some applications it is necessary to select a plastic that provides a high service temperature compared to polyethylene but which is less rigid than a polypropylene homopolymer. In such cases, polypropylene copolymer types are used. In this context we distinguish between PP block copolymers (PP-B), which are made up of two or more large blocks of PP and PE, and PP random copolymers (PP-R), which consist of propylene and ethylene monomers in a random sequence.

PP-B and PP-R are tougher, especially at low temperatures below 5 °C. However, they have a lower level of rigidity than PP-H, particularly at temperatures above 60 °C.

SIMONA® PP-C semi-finished products are block polymer PP types (PP-B). In addition, our product range comprises sheets, welding rods, fittings and valves made of SIMONA® PP-R. Under certain circumstances (e.g. compliance with the melt flow index range or filler proportion) PP-H can be combined or welded with PP-B or PP-R.

Furthermore, there are other options for a copolymer as regards its constituent elements, e.g. alternating copoly-

mers or grafted copolymers. Apart from PP-C, acrylonitrile butadiene styrene (ABS), styrene acrylonitrile (SAN) and butyl rubber are copolymers that are widely used in technical applications.

3.4 Polyvinyl chloride (PVC-U)

PVC-U is a homopolymer with scarcely branched macromolecular chains having a molar mass M of between 40,000 and 150,000.

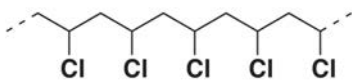

Figure 16: Diagram of PVC-U

The lateral chlorine atoms are spaced at random (atactic) along the molecular chains. The large chlorine atoms prevent a parallel arrangement of the main chains. Crystallisation is therefore impossible. This explains the amorphous molecular structure.

Depending on the manufacturing process of the PVC, we can distinguish between three types of polymerisation:

1. Mass polymer (M-PVC)

In substance polymerisation or mass polymerisation the vinyl chloride is provided with an initiator and polymerised without any solvent. Owing to the low content of polymerisation aids, a very high degree of purity is achieved. For this reason such a PVC-U can be used to manufacture end products with a particularly high-quality appearance.

2. Suspension polymer (S-PVC)

If the monomer is dispersed in a non-miscible medium (often water) and a monomer-soluble initiator is added, the process is referred to as suspension polymerisation. Polymerisation takes place in the dispersed monomer droplets. The end product is transparent, universal in terms of application and possesses good electrical insulation properties.

3. Emulsion polymer (E-PVC)

As opposed to suspension polymerisation, in emulsion polymerisation a water-soluble initiator and emulsifiers are added. For this reason, clouding can occur on account of the emulsifier content required for polymerisation. During storage, moisture can be absorbed, having a negative influence on electrical insulation properties.

Like polyolefins, PVC is manufactured as a homopolymer and copolymer. The copolymer components commonly used are vinyl acetate and acrylonitrile. Copolymers are tougher, more flexible and more impact resistant than homopolymers.

Since pure PVC does not have a balanced property profile and tends towards thermal decomposition when subjected to further processing by extrusion, calendaring or injection moulding, it has to be prepared by adding processing aids and modifiers. Such additives include UV stabilisers, thermostabilisers, plasticizers, lubricants, pigments, fillers, impact resistance modifiers and possibly antistatic agents as well.

SIMONA only processes rigid PVC (PVC-U = PVC unplasticized). Plasticized PVC (PVC-P = PVC plasticized) is a material (a mixture of PVC with other polymers) that contains more than 20% plasticizer. Plasticized PVC has elastomer-like behaviour at ambient temperature so it is tough and very flexible. The most important fields of application are cable sheathings and films.

Relevant standards and guidelines refer not only to PVC-U but also to other plasticizer-free PVC types such as PVC-HI.

PVC-HI (High Impact) grades are types that have raised impact resistance to high impact resistance. They are made by letting down PVC-U soft elastic substances (impact resistance modifiers) based on PAE, PE-C, EVAC, VAC, etc. Consequently, they are two-phase materials consisting of a PVC homopolymer and an impact resistance modifier. The type and quantity of impact resistance modifier used depends on the properties to be achieved. Up to 12% modifier is normally used. SIMONA offers an impact resistance-modified PVC in various colours: SIMONA® PVC-MZ-COLOR.

On account of very high proportions of modifier, you usually have to accept some limitations with regard to chemical resistance and thermal resistance.

3.5 Post-chlorinated polyvinyl chloride (CPVC)

PVC-U can be post-chlorinated using special processes, thus creating a PVC with a chlorine proportion higher than 60%. It can be more difficult to process than PVC-U but it has higher thermal stability above 60 °C and is particularly resistant to chlorine attack. Technically it

has become established in many areas of the chemical industry and for use in the field of hot water piping.

3.6 Polyvinylidene fluoride (PVDF)

PVDF belongs to the group of partially fluorinated thermoplastics.

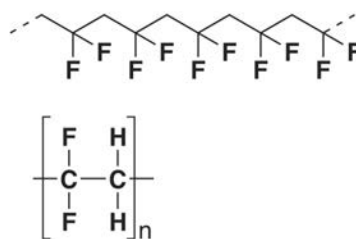

Figure 17: Diagram of PVDF

Like PVC, partially crystalline PVDF can be manufactured either by emulsion polymerisation or by suspension polymerisation. Scientific literature describes emulsion polymerisation as an important polymerisation process which in organic chemistry is also regarded as one of the most significant large-scale industrial processes.

On account of their high chemical resistance and thermal stability, fluoroplastics are used in plant construction and for pressure pipelines, especially in the chemical industry. Their properties depend on the particular fluorine content. The higher the fluorine component, the higher the continuous service temperature, flame resistance and chemical resistance.

SIMONA® PVDF has a fluorine content of about 57%, which ensures a high level of chemical resistance up to temperatures of 120 °C. However, the chemical resistance is very much dependent on the particular medium being conveyed. PVDF only exhibits weaknesses in the alkaline range, when pH is above 10.

3.7 Ethylene chlorotrifluoroethylene (ECTFE)

Like the PVDF mentioned, ECTFE belongs to the partially fluorinated thermoplastics. This material is a copolymer consisting of ethylene and chlorotrifluoroethylene. The comonomer ratio is approximately 1:1.

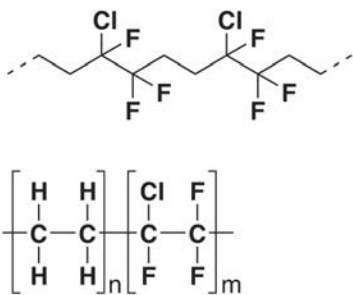

Figure 18: Diagram of ECTFE

On account of its chemical and physical properties, this partially crystalline thermoplastic is chiefly used in the chemical industry, where a high level of corrosion resistance is required. Applications of this material are mainly found in the lining of steel tanks and in composite design in conjunction with GRP (glass-fibre reinforced plastic). Since fluorinated plastics, like polyolefins, cannot be glued, or only under certain circumstances, on account of their surface energy, so-called backed materials are available. These are provided with a textile fabric on the back, which enables the glue to become mechanically attached to the plastic sheet. Such textile fabrics are usually made of polyester, polypropylene, aramid or glass fibre.

The chemical resistance of ECTFE is usually between that of PVDF and PTFE. However, unlike PVDF, ECTFE has good chemical resistance in the alkaline range above a pH value of 10.

Furthermore, ECTFE is characterised by a low permeation coefficient, which is particularly beneficial in composite construction. Just like PVDF, ECTFE is transparent for the UV-A and UV-B ranges of the spectrum. Thus, no chemical degradation due to light occurs in that frequency range.

However, the processing of ECTFE is slightly more critical than that of PVDF because the welding temperature has a narrower window. This also applies to thermoforming because from about 165 °C upwards ECTFE has reduced elongation at break.

3.8 Ethylene tetrafluoroethylene (ETFE)

ETFE is a derivative of the plastics PTFE or ECTFE; it is manufactured by copolymerisation from the monomers ethylene and tetrafluoroethylene. In terms of properties it is similar to ECTFE; it surpasses the latter in some areas on account of its high fluorine content.

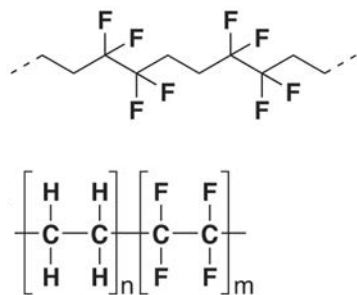

Figure 19: Diagram of ETFE

3.9 Perfluoroalkoxy copolymer (PFA)

The most well-known fully fluorinated thermoplastic is PTFE (polytetrafluoroethylene), which in many technical fields is used up to approximately 260 °C on account of its chemical resistance and high service temperature limit. The drawback with this material is that it cannot be welded under normal conditions. For this reason a PTFE derivative was developed which combines high chemical resistance and service temperature with good weldability.

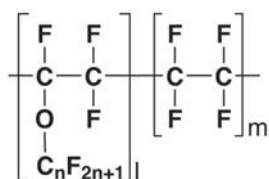

Figure 20: Diagram of PFA

PFA has precisely these properties and can even be used up to 260 °C. It is also resistant to virtually all chemically aggressive media. The only disadvantage is its high price, as a result of which the material is only used when no alternative is available. Another benefit of this material is its high purity, so in borderline cases with high-purity requirements, e.g. in semiconductor technology, PFA is used as one of the few alternatives.

It is worth noting that various PFA types are available which may differ in terms of their specific capabilities, e.g. maximum service temperature. Differentiation all depends on the length of the side chain (variable n; cf. Figure 20). Chain lengths of n = 1 or n = 3 are common. If n = 1, the proper term is MFA, but if n = 3, it is PFA. Chemically, both are PFA modifications. SIMONA offers both MFA and PFA: SIMONA® PFA-M and SIMONA® PFA.

Table 4 lists mechanical properties compared to those of other materials. The high rigidity of PVDF means it is an ideal structural material for high technical demands. In addition, this material has high notched impact strength, which even down to temperatures of -30 °C turns out to be relatively high, so service properties remain intact at low temperatures.

	Unit	PE-HD	PVC-CAW	PVDF	PFA
Density	g/cm ³	0.95	1.44	1.78	2.17
Fluorine content	%	0	0	57	76
Yield stress	MPa	23	58	56	14
Tensile strain at yield stress	%	9	4	10	50
Notched impact strength	kJ/m ²	16	4	12	≤15
Service temperature upper limit	°C	80	60	140	250

Table 4: Properties of various thermoplastics

3.10 Glycol-modified polyethylene terephthalate (PETG)

PETG is a copolymer of a thermoplastic polyester. Since crystallisation is prevented, the material is transparent.

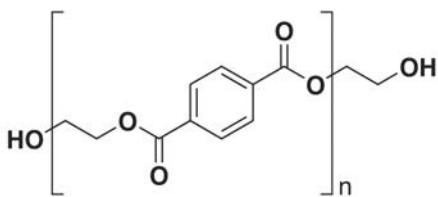

Figure 21: Diagram of PETG

The G stands for a glycol modification that gives the material a high level of impact strength.

PETG has the following properties:

- Transparent with light transmission of up to 93%
- Service temperature range from -40°C to $+65^{\circ}\text{C}$
- Physiologically safe
- Suitable for outdoor use to a limited extent
- B1 low flammability (DIN 4102)
- Halogen-free
- High toughness with good rigidity
- Excellent forming properties and thermoformability
- Easy to glue

SIMONA AG markets this material under the name of SIMOLUX.

3.11 Polylactic acid (PLA)

Poly lactides also rank among the polyesters and as biocompatible plastics they are often also manufactured from natural resources. Owing to an asymmetric carbon atom in the polymer backbone, PLA is an optically active polymer; it can occur either in the D-form or the L-form (optical activity of the molecule).

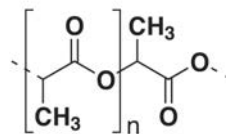

Figure 22: Diagram of PLA

Poly lactides are chiefly manufactured by ionic polymerisation of lactide, a cyclic diester of lactic acid. The mechanical properties of pure PLA are very similar to those of polyethylene terephthalate (PET).

On account of its molecular structure PLA can be biologically split. Therefore, under certain conditions it is biodegradable. Such conditions are normally only found in industrial composting plants. Also, biodegradability depends to a large extent on chemical composition.

PLA is one of the most commonly used materials for so-called „Additive Manufacturing (AM)“, which is better known as 3D printing.

SIMONA AG markets this material under the names of SIMOGREEN PLA and SIMOGREEN PLA-HT (high temperature). The material is available in sheets and as a filament for 3D printing.

3.12 Polyamides (PA)

Polyamides, also known by the name of nylon, are based on amide groups that can form so-called hydrogen bridges with one another, which are of major importance for properties such as strength. The numerical combination after the polyamides indicates the size or chain length of the basic units, i.e. of the diamine and the dicarboxylic acid, but if there is only one number it indicates that of the lactam (cyclic amide). From a technical perspective, the key representatives of this class of partially crystalline thermoplastic polymers are, for example, PA 6.6 and PA 6.10 or PA 6 and PA 12. Aromatic polyamides are also termed polyaramides.

a)

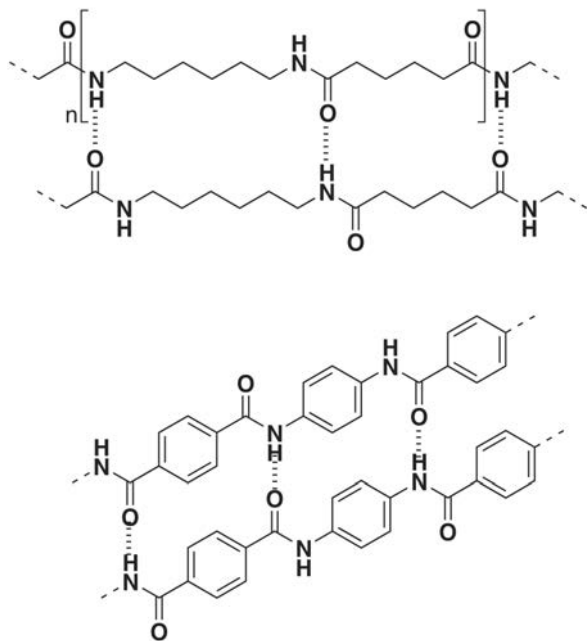

Figure 23: Polyamides cross-linked by means of hydrogen bridges;

a) Polyamide 4.6;

b) Poly(p-phenylene terephthalamide) (PPTA)

Many polyamides are characterised by high strength, rigidity and toughness, possess good chemical resistance, high wear resistance, good slip properties and processing capability, but they are sensitive to hydrolysis, especially at high temperatures.

3.13 Polymethyl methacrylate (PMMA)

PMMA is usually atactic and amorphous. It is transparent and transmits light even more efficiently than mineral glass. PMMA can be dyed and is weather-resistant.

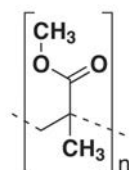

Figure 24: Diagram of PMMA

In the trade, PMMA is usually marketed under the name of acrylic glass.

The main fields of application are window panes, headlamp covers, complete dentures and partial dentures in dentistry, or optical components such as spectacle lenses or watch glasses.

3.14 Polycarbonate (PC)

In formal terms, polycarbonates are polyesters of carbonic acid. They are usually amorphous so they are also transparent. However, they can be dyed and are characterised by high strength, impact strength and hardness. Polycarbonates are used, inter alia, as materials for data storage devices such as CDs, DVDs or Blu-ray discs or as glazing for visors and greenhouses.

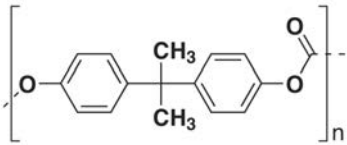

Figure 25: Diagram of PC made of phosgene and bisphenol A

In the SIMONA® product range, polycarbonates are to be found in the product SIMONA® PC-Blend. However, this product is no longer transparent because of its polymer mixture.

4 Material specifications

All SIMONA® products are characterised by a high level of quality. The consistency of this high standard of our products is ensured by subjecting them to continuous internal and external monitoring.

- Monitoring of creep tests on pipes by the South German Plastics Centre („SKZ“), Würzburg, and TÜV Süd, Munich.
- Monitoring of tests for media effects on thermoplastic materials by the Institute for Plastics of TÜV Süd, Munich.
- Monitoring of extruded and pressed moulding materials made of thermoplastics for tank construction requiring mandatory test certificates, conducted by the Institute for Plastics of TÜV Süd, Munich.

These measures are of special importance for tank construction requiring mandatory test certificates and approval. In addition, the European Pressure Equipment Directive, 97/23/EC, has been in force since 1 June 2002. For approval of pressure equipment, approval test certificates to Article 3.1 must be presented for semi-finished products, depending on the hazard class. The specifications of semi-finished products must be verified in the batch and certified accordingly.

Within the scope of in-process inspections by in-plant quality assurance conforming to DIN EN ISO 9001, all the important mechanical, thermal and optical properties are checked and documented.

Documentation of the measured data is used for statistical analysis and self-monitoring. The specifications declared on the Technical Data Sheets are average fig-

ures obtained from many years of testing. It is not always possible to apply those specifications to different wall thicknesses or semi-finished products that have been manufactured by different production processes.

The specifications listed on the Technical Data Sheets are designed to enable the user to identify the material with the most suitable property profile for a certain application. However, only some of those figures can be used for sizing components. When structurally sizing pipes and tanks it is necessary to consider not only the data listed there but also the long-term specifications. The latter can be found in the relevant industrial standards, in DVS 2205 and in DVS 2210.

The figures are approximate, relate to the particular material and may vary depending on the fabrication process and how test specimens are made. They are usually averages of measurements on extruded sheets 4 mm thick. In the case of sheets solely manufactured by the pressing method they are usually measurements on sheets with a thickness of 20 mm. There may be discrepancies if sheets are not available in those thicknesses. In the case of backed sheets the specifications relate to unbacked basic sheets. The figures cannot necessarily be applied to other product types (e.g. pipes, solid rods) made of the same material or to products that have been subjected to further processing. It is the processing company or user who is responsible for testing whether materials are suitable for a specific application. The specifications are merely a planning aid. In particular, they are not guaranteed properties. You can obtain further information from our Technical Service Centre at tsc@simona.de.

4.1 PE

Material specifications

			SIMONA® PE 100 black	SIMONA® PE 100 natural	SIMONA® PE-HD black	SIMONA® PE-HD natural
Density	g/cm ³	DIN EN ISO 1183	0.96	0.96	0.96	0.95
Yield stress	MPa	DIN EN ISO 527	23	23	23	23
Elongation at yield	%	DIN EN ISO 527	9	9	9	9
Tensile modulus of elasticity	MPa	DIN EN ISO 527	1 100	1 100	1 100	1 100
Impact strength	kJ/m ²	DIN EN ISO 179	no break	no break	no break	no break
Notched impact strength	kJ/m ²	DIN EN ISO 179	25	21	16	16
Ball indentation hardness	MPa	DIN EN ISO 2039-1	40	40	43	43
Shore hardness D (15 s)		DIN EN ISO 868	64	64	65	65
Mean coefficient of linear thermal expansion	K ⁻¹	ISO 11359-2	1.8 x 10 ⁻⁴	1.8 x 10 ⁻⁴	1.8 x 10 ⁻⁴	1.8 x 10 ⁻⁴
Thermal conductivity	W/m · K	DIN 52612	0.38	0.38	0.38	0.38
Fire behaviour		DIN 4102	B2 [Ⓣ]	B2 [Ⓣ]	B2 [Ⓣ]	B2 [Ⓣ]
Dielectric strength	kV/mm	DIN IEC 60243-1	47	47	–	–
Specific surface resistance	Ohm	DIN IEC 60093	≥ 10 ¹⁴	≥ 10 ¹⁴	≥ 10 ¹⁴	≥ 10 ¹⁴
Temperature range	°C		-50 to +80	-50 to +80	-50 to +80	-50 to +80
Chemical resistance			excellent in contact with many acids, alkalis and solvents			
Physiologically safe		BfR	✓	✓	✓	✓
Food conformity		EU	✓	✓	✓	✓
		FDA	–	✓	–	✓

[Ⓣ] Self-assessment without test certificate

Material specifications

			SIMONA® PE-EL	SIMONA® PE 500	SIMONA® PE 1000
Density	g/cm ³	DIN EN ISO 1183	0.99	0.95	0.93
Yield stress	MPa	DIN EN ISO 527	26	28	19
Elongation at yield	%	DIN EN ISO 527	7	8	11
Tensile modulus of elasticity	MPa	DIN EN ISO 527	1 300	1 100	700
Impact strength	kJ/m ²	DIN EN ISO 179	no break	no break	no break
Notched impact strength	kJ/m ²	DIN EN ISO 179	6	–	–
		DIN EN ISO 11542-2	–	18	180
Ball indentation hardness	MPa	DIN EN ISO 2039-1	50	–	30
Shore hardness D (15 s)		DIN EN ISO 868	67	65	60
Mean coefficient of linear thermal expansion	K ⁻¹	ISO 11359-2	1.8 x 10 ⁻⁴	1.8 x 10 ⁻⁴	1.8 x 10 ⁻⁴
Vicat B	°C	DIN EN ISO 306	–	80	82
Fire behaviour		DIN 4102	B2 ^⓪	B2 ^⓪	B2 ^⓪
Dielectric strength	kV/mm	DIN IEC 60243-1	–	44	44
Specific surface resistance	Ohm	DIN IEC 60093	≤ 10 ⁶	≥ 10 ¹⁴	≥ 10 ¹⁴
Temperature range	°C		-20 to +80	-100 to +80	-260 to +80
Chemical resistance			excellent in contact with many acids, alkalis and solvents		
Physiologically safe		BfR	–	✓	✓
Food conformity		EU	–	✓	✓
		FDA	–	✓	✓

^⓪ Self-assessment without test certificate

4.2 PP

Material specifications

			SIMONA® PP-H AlphaPlus®	SIMONA® PP-H natural	SIMONA® PP-C	SIMONA® PP-EL-S	SIMONA® PPs
Density	g/cm ³	DIN EN ISO 1183	0.91	0.90	0.91	1.17	0.95
Yield stress	MPa	DIN EN ISO 527	33	32	26	25	32
Elongation at yield	%	DIN EN ISO 527	8	8	7	7	8
Tensile modulus of elasticity	MPa	DIN EN ISO 527	1 700	1 400	1 200	1 400	1 600
Impact strength	kJ/m ²	DIN EN ISO 179	no break	no break	no break	no break	no break
Notched impact strength	kJ/m ²	DIN EN ISO 179	9	7	45	5	6
Ball indentation hardness	MPa	DIN EN ISO 2039-1	–	–	50	66	70
Shore hardness D (15 s)		DIN EN ISO 868	72	70	67	70	72
Mean coefficient of linear thermal expansion	K ⁻¹	ISO 11359-2	1.6 x 10 ⁻⁴	1.6 x 10 ⁻⁴	1.6 x 10 ⁻⁴	1.6 x 10 ⁻⁴	1.6 x 10 ⁻⁴
Thermal conductivity	W/m · K	DIN 52612	0.22	0.22	0.22	–	0.22
Fire behaviour		DIN 4102	B2 ^①	B2 ^①	B2 ^①	B2 ^①	B1: 2 – 20 mm ^②
		UL 94	–	–	–	V0: ≥ 4 mm ^②	–
Dielectric strength	kV/mm	DIN IEC 60243-1	–	–	52	–	22
Specific surface resistance	Ohm	DIN IEC 60093	10 ¹⁴	10 ¹⁴	10 ¹⁴	≤ 10 ⁶	10 ¹⁴
Temperature range	°C		0 to +100	0 to +100	-20 to +80	0 to +80	0 to +100
Chemical resistance			excellent in contact with many acids, alkalis and solvents				
Physiologically safe		BfR	✓	✓	✓	–	–
Food conformity		EU	✓	✓	–	–	–
		FDA	✓	✓	✓	–	–

^① Self-assessment without test certificate

^② Test certificate available

4.3 Rigid PVC

Material specifications

			SIMONA® PVC-CAW	SIMONA® PVC-MZ-COLOR	SIMONA® PVC-GLAS	SIMONA® CPVC CORZAN Industrial Grade	SIMONA® PVC-KYRNIT®
Density	g/cm ³	DIN EN ISO 1183	1.44	1.42	1.37	1.52	1.39
Yield stress	MPa	DIN EN ISO 527	58	55	73	51	63
Elongation at yield	%	DIN EN ISO 527	4	4	4	5	4
Tensile modulus of elasticity	MPa	DIN EN ISO 527	3 300	3 100	3 300	2 500	3 100
Impact strength	kJ/m ²	DIN EN ISO 179	–	–	–	no break	no break
Notched impact strength	kJ/m ²	DIN EN ISO 179	4	8	3	8	4
Shore hardness D (15 s)		DIN EN ISO 868	82	82	84	80	81
Mean coefficient of linear thermal expansion	K ⁻¹	ISO 11359-2	0.8 x 10 ⁻⁴	0.8 x 10 ⁻⁴	0.8 x 10 ⁻⁴	0.7 x 10 ⁻⁴	0.7 x 10 ⁻⁴
Vicat B	°C	DIN EN ISO 306	74	74	66	112	75
Fire behaviour		DIN 4102	B1: 1 - 4 mm ^②	B1: 1 - 4 mm ^①	B1: 1 - 4 mm ^②	B1 ^①	B1 ^①
		UL 94	V0: ≥ 1 mm ^②	–	V0: ≥ 1 mm ^②	–	–
		NF P 92-501	M1: 1 - 3 mm ^②	–	M1: 1 - 3 mm ^②	–	–
		BS 476	Class 1: 3 mm ^②	–	Class 1: 3 mm ^②	–	–
Dielectric strength	kV/mm	DIN IEC 60243-1	39	34	30	–	–
Specific surface resistance	Ohm	DIN IEC 60093	10 ¹³	10 ¹⁴	10 ¹⁴	10 ¹⁵	10 ¹³
Temperature range	°C		0 to +60	-20 to +60	0 to +60	-40 to +95	0 to +60
Chemical resistance			excellent in contact with many acids and alkalis				
Physiologically safe		BfR	–	–	–	–	–

① Self-assessment without test certificate

② Test certificate available

4.4 Foamed PVC

Material specifications

			SIMOPOR-LIGHT	SIMOPOR-LIGHT BRILLIANT	SIMOPOR- ULTRALIGHT	SIMOPOR- COLOR	SIMONA® COPLAST-AS
Density	g/cm ³	DIN EN ISO 1183	0.55	0.50	0.47	0.58	0.67
Yield stress	MPa	DIN EN ISO 527	16	15	15	16	18
Elongation at yield	%	DIN EN ISO 527	3	3	3	3	3
Tensile modulus of elasticity	MPa	DIN EN ISO 527	900	850	600	1 000	1 100
Flexural modulus of elasticity	MPa	DIN EN ISO 178	1 100	1 000	930	1 400	1 400
Impact strength	kJ/m ²	DIN EN ISO 179	12	12	12	12	19
Shore hardness D (15 s)		DIN EN ISO 868	35	32	30	35	70
Mean coefficient of linear thermal expansion	K ⁻¹	ISO 11359-2	0.7 x 10 ⁻⁴	0.7 x 10 ⁻⁴	0.7 x 10 ⁻⁴	0.7 x 10 ⁻⁴	0.83 x 10 ⁻⁴
Fire behaviour		DIN 4102	B1: 1 - 19 mm ^②	—	B2 ^①	B2 ^①	B2 ^① B1: 10 mm ^③
		NF P 92-501	M1: 3 - 10 mm ^②	M1: 2 - 10 mm ^②	—	—	M1: 10 mm ^③
		DIN EN 13501-1	—	Euroclass C-s3-d0: 2 - 10 mm ^④	—	—	—
Specific surface resistance	Ohm	DIN IEC 60093	> 10 ¹⁵	> 10 ¹⁵	> 10 ¹⁵	> 10 ¹⁵	≤ 10 ¹²
Temperature range	°C		0 to +60	0 to +60	0 to +60	0 to +60	0 to +60
Chemical resistance			excellent in contact with many acids, detergents and alcohols				
Physiologically safe		BfR	—	—	—	—	—

① Self-assessment without test certificate

② Test certificate available

③ on request

④ Test certificate as of end 2016

4.5 PETG, PVDF, ECTFE, PFA

Material specifications

			SIMOLUX (PETG)	SIMONA® PVDF	SIMONA® ECTFE	SIMONA® PFA
Density	g/cm ³	DIN EN ISO 1183	1.27	1.78	1.68	2.15
Yield stress	MPa	DIN EN ISO 527	52	55	31	15
Elongation at yield	%	DIN EN ISO 527	4.5	8	4	–
Tensile modulus of elasticity	MPa	DIN EN ISO 527	1 900	1 950	1 650	450
Notched impact strength	kJ/m ²	DIN EN ISO 179	10	12	≥ 100	no break
Ball indentation hardness	MPa	DIN EN ISO 2039-1	97	120	56	–
Shore hardness D (15 s)		DIN EN ISO 868	78	78	67	55
Mean coefficient of linear thermal expansion	K ⁻¹	ISO 11359-2	–	1.3 x 10 ⁻⁴	1.0 x 10 ⁻⁴	1.4 x 10 ⁻⁴
Fire behaviour		DIN 4102	B1: 1 – 8 mm [Ⓜ]	B1 [Ⓢ]	B1 [Ⓢ]	B1 [Ⓢ]
Dielectric strength	kV/mm	DIN IEC 60243-1	16	25	23	33
Specific surface resistance	Ohm	DIN IEC 60093	10 ¹⁴	10 ¹⁴	10 ¹⁴	10 ¹⁵
Temperature range	°C		-40 to +65	-30 to +140	-40 to +150	-190 to +260
Chemical resistance			on request	excellent to almost all chemicals	extremely good, also in the alkaline range	extremely good, chemically attacked by few substances only
Physiologically safe		BfR	✓	✓	–	–
Food conformity		EU	✓	✓	–	–
		FDA	✓	✓	–	✓

[Ⓢ] Self-assessment without test certificate

[Ⓜ] Test certificate available

5 Physical properties

5.1 Mechanical properties

In mechanics a general distinction is drawn between elastic and plastic deformation of materials. If there is a linear relationship between the stress acting on a body and the resulting strain, that material obeys Hooke's law and it behaves in a linear elastic manner ("·" represents multiplication symbol):

$$\sigma = E \cdot \varepsilon$$

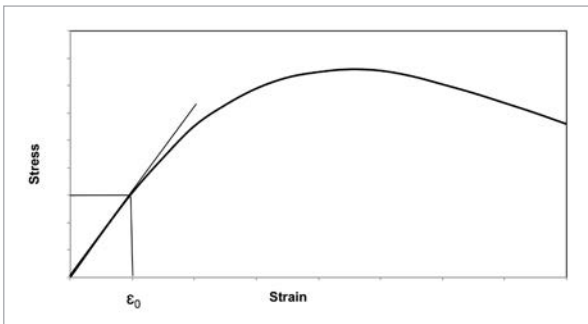

Figure 26: Stress-strain diagram

In this case, σ stands for the stress acting on the workpiece (force per unit area), ε stands for the strain (increase in length in relation to initial length $\Delta L/L_0$) and E stands for the modulus of elasticity, which is also referred to as rigidity. In the range of low strains (0.2% proof stress), metal and ceramic materials behave in a linear elastic manner.

Using a unidirectional tensile test, it is possible to determine the modulus of elasticity from the slope of the curve by plotting measured stress against strain. The strain generated within Hooke's straight line is reversible and as the external load decreases it returns to its original state. A similar relationship exists for shearing forces between shear stress τ and the angle change caused by it γ ; G is referred to as shear modulus:

$$\tau = \gamma \cdot G$$

If you consider elastic isotropic materials, the shear modulus and modulus of elasticity do not exist independently of one another but are interlinked by the following relationship:

$$G = \frac{E}{2(1+\nu)}$$

ν is the absolute ratio of transverse strain to axial strain, which is also referred to as Poisson's ratio. Poisson's ratio is the amount of the quotient of transverse contraction $\Delta D/D_0$ (D_0 = specimen diameter, ΔD = change in diameter) and strain $\Delta L/L_0$ and it is normally less than 0.5. This means that when the material is subjected to a load there will be a more or less substantial increase in volume.

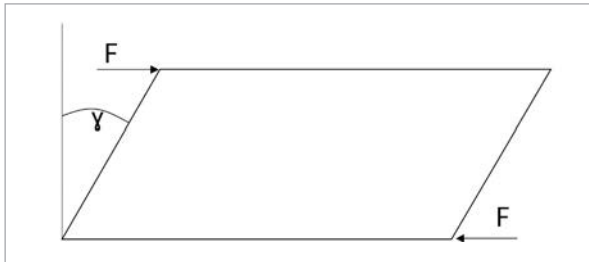

Figure 27: Principle of the shear test

In the range of low strains, solid plastics, on the other hand, can display elastic and viscoelastic properties. The elasticity of plastics is also subdivided into energy elasticity and entropy elasticity. Energy elasticity is caused by restoring forces relating to the atoms moved out of the state of equilibrium as a result of the external load. Entropy elasticity is brought about by a change in entropy in the system, which is due to a change in the state of order. Ideal rubber elasticity, for example, is a pure form of entropy elasticity. In real plastics there is usually a mixture of the two forms of elasticity; the energy-elastic component is often dominant.

Viscoelasticity is the time-dependent elasticity of a material. This means that when a plastic is subjected to a spontaneous mechanical load it has a delayed reaction. Consequently, the mechanical parameters of a viscoelastic material no longer constitute constants but become time-dependent. The cause of this behaviour can be explained by the restoring processes in and between the chain molecules. They take place on a diffusion-controlled basis so they are time-dependent. The flattening-out of the reaction of a viscoelastic body is asymptotic, so in reality it is never completed and at any moment the

deformation is a function of previous history. For calculation of the linear viscoelastic state it is assumed that the plastic is composed of springs and dampers connected in series and in parallel.

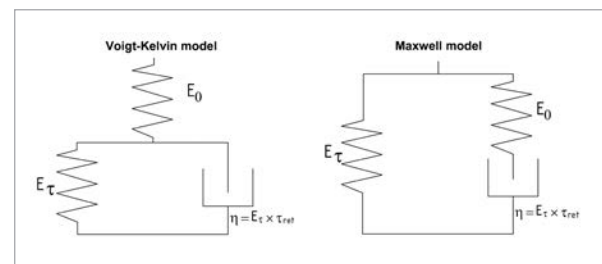

Figure 28: Mechanical models of the viscoelastic body

Stress relaxation is obtained by elongating the material to a constant value and observing the flattening-off of stress $\sigma(t)$ (Figure 29). It is a function of the time-independent and time-dependent moduli E_0 and E_t :

$$\sigma(t) = \varepsilon_0 \cdot E_0 + \varepsilon_0 \cdot E_t \cdot \exp(-t/\tau_{rel})$$

Relaxation time τ_{rel} is the time after which the reaction has flattened out to an e-th ($e \approx 2.7183$) of the initial value. According to the Maxwell model (Figure 28), it is possible to imagine that during sudden stretching a stress is built up by spring forces and then relaxed by the stretching of the damping link.

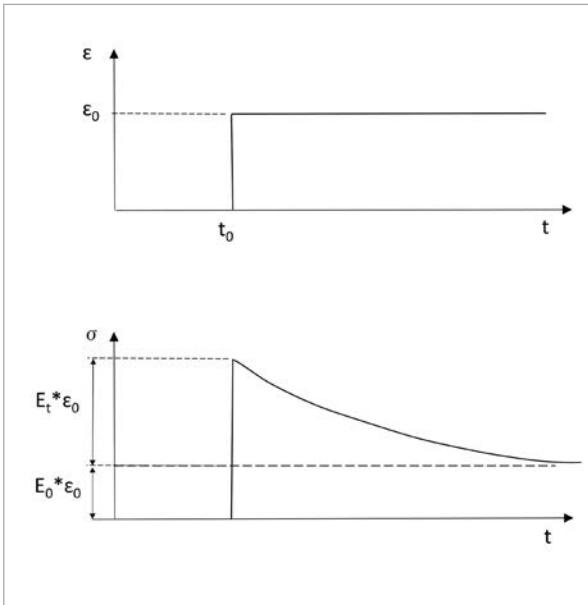

Figure 29: Stress relaxation

During creep the body is exposed, within a defined period of time t_1 , to a stress σ_0 and recovery (retardation) $\varepsilon(t)$ is observed (Figure 30):

$$\varepsilon(t) = \varepsilon_0 + \varepsilon_t \cdot \exp(-t/\tau_{ret})$$

Whereby τ_{ret} is the time up to which the reaction to the stress has flattened out to an e-th of the initial value and ε_t is the strain dependent on retardation processes.

According to the Voigt-Kelvin model, in the case of creep it is possible to imagine that after impression of a constant stress the spring elements expand according to their spring constants. Then the damping link is elongated and total strain increases. After relaxation, the spring

elements (σ_0/E_0) first relax and after that the damping element returns to its position of rest. If the strain rate is constant ($\dot{\varepsilon} = \text{const.}$), the slope of the stress-strain curve is dependent on time such that with a decreasing strain rate the curve takes a more downward turn because the relaxation processes have more time available to reduce the stresses:

$$\sigma(t) = E_0 \cdot \varepsilon + E_t \cdot \varepsilon_0 \cdot [1 - \exp(-\tau_{rel}^{-1} \cdot t)]$$

If the above relationship is differentiated, it is evident that the slope $d\sigma/d\varepsilon$ only depends on the time t and not on the strain rate $\dot{\varepsilon}$ when one takes into account the fact that each slope is determined at the same point in time:

$$\frac{d\sigma}{d\varepsilon} = E_0 + E_t \cdot \exp\left(-\frac{t}{\tau_{rel}}\right)$$

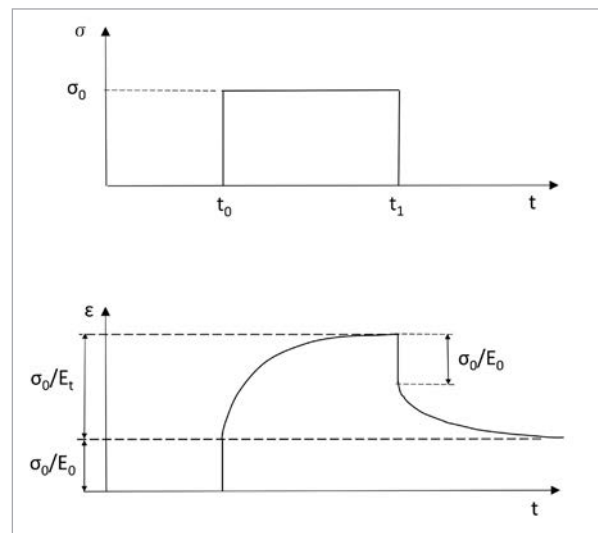

Figure 30: Creep and creep recovery

In reality, the behaviour of plastics is much more complex. Therefore, to describe viscoelastic behaviour, so-called retardation and relaxation spectra have to be obtained. The reason for this is that the restoring processes are triggered by complex interactions due to different bonding characteristics within the plastic. Since the relaxation times of plastics are attributable to molecular movements, they depend on temperature and, like most thermally activated processes, they obey the Arrhenius equation:

$$\tau = B \cdot \exp\left(\frac{W}{k \cdot T}\right)$$

In the above equation B is a material-specific constant, W is the activation energy, k is the Boltzmann constant and T is the absolute temperature. Consequently, it is possible to create identical mechanical conditions by selecting the temperature or time, or in other words, it is possible to perform acceleration by means of process control at a raised temperature.

From the above description it is evident that in a short-term test, i.e. when testing time is much shorter than reaction time, or in a low-temperature test when molecular movements are frozen, no viscoelasticity occurs. In such a case the behaviour of the material is linear elastic.

Similar to tensile stress and flexural stress, the reaction of a viscoelastic body also reacts in a delayed manner when subjected to a dynamic load. For this reason a lag occurs between the impressed stress and the strain. In complex notation the equations for sinusoidal stress $\sigma(t)$ and strain $\varepsilon(t)$ are as follows:

$$\begin{aligned}\sigma(t) &= \sigma_0 \cdot \exp(i\omega t) \text{ and} \\ \varepsilon(t) &= \varepsilon_0 \cdot \exp(i\omega t + \delta)\end{aligned}$$

The lag δ is 0° for ideal elastic bodies and for ideal viscous fluids it is 90° . The complex formula results in a modulus of elasticity that is also represented at a complex numerical level:

$$\frac{d\sigma}{d\varepsilon} = E = E' + iE''$$

E' is the energy stored elastically during every vibration, so it is termed storage modulus:

$$E' = E_0 + E_t \cdot \frac{\omega^2 \cdot \tau_{rel}^2}{1 - \omega^2 \cdot \tau_{rel}^2}$$

E'' can be converted to energy, which equals the energy dissipated irreversibly and is therefore defined as loss modulus:

$$E'' = E_t \cdot \frac{\omega^2 \cdot \tau_{rel}^2}{1 - \omega^2 \cdot \tau_{rel}^2}$$

The quotient of E'' and E' equals the tangent δ and results in the loss factor d :

$$d = \tan \delta$$

The consequence of this vibrating characteristic of linear viscoelastic materials is the fact that although the behaviour of such a material is mechanically reversible it is thermodynamically irreversible and thus consumes energy. Plastics therefore have a high damping potential, which can be exploited in engineering in the form of noise control.

5.1.1 Mechanical properties of thermoplastics

Thermoplastics consist of relatively long, scarcely branched polymer chains that are not chemically linked to one another. The individual chain molecules are physically connected to one another by so-called van der Waals forces, so their bonds are reversible. For this reason, they also flow at relatively high temperatures and can be welded to one another.

Thermoplastics can be in an amorphous form or a partially crystalline form. Crystallinity occurs to a varying extent in areas where the chain molecules are parallel to one another. Amorphous and partially crystalline thermoplastics are evident from their different elastic properties, depending on temperature.

At temperatures above the glass transition temperature T_G amorphous thermoplastics are not very strong and have a low modulus of elasticity, which decreases rapidly with temperature. In the glass transition range, amorphous thermoplastics tend to soften.

Glass transition temperature is defined as the temperature at which vacancy volume freezes. This vacancy volume enables a certain amount of free mobility of molecules and molecular chains. For this reason vacancy volume is often referred to as free volume.

The total volume of a plastic consists of vacancy volume V_L , vibration volume V_S and the volume of the molecule V_M . When the glass transition has been reached, the only volume that changes is vibration volume V_S (Figure 31).

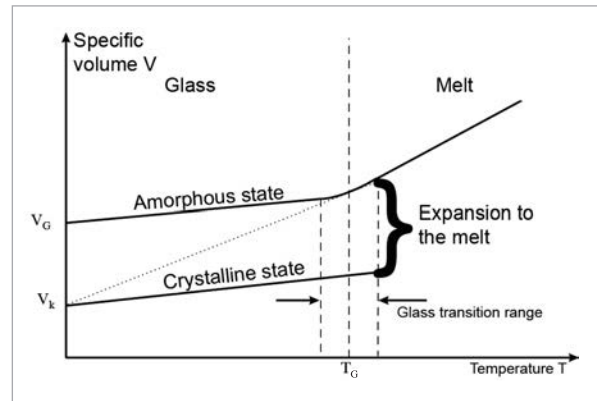

Figure 31: Change in specific volume with temperature

Partially crystalline thermoplastics are less dependent on temperature between T_G and crystalline melting temperature T_s . Only above T_s do the mechanical figures drop significantly and the material begins to soften or melt.

Partially crystalline thermoplastics usually have a high level of elongation at break, which can be anything up to 800% (e.g. PE). Their modulus of elasticity is relatively low and can be less than 200 MPa even at room temperature. In addition, thermoplastics tend to creep, which can be problematical especially at high temperatures. Furthermore, owing to their chemical/physical bonding characteristics, thermoplastics have a high level of damping so the materials are good mechanical damping elements.

Thermoplastics	Tensile strength MPa	Modulus of elasticity MPa	Elongation at break %	Notched impact strength kJ/m ²
PVC-U	50 - 65	3,000	20 - 50	2 - 5
CPVC	75	3,500	10 - 15	2
PE-HD	20 - 30	700 - 1,200	400 - 800	6 - 15
PP-H	25 - 40	1,000 - 1,300	70 - 500	3 - 9
PVDF	50 - 60	2,400	20 - 80	22
ECTFE	32 - 40	1,700	200 - 300	-
FEP	20 - 30	350 - 500	250 - 350	-
PFA	15 - 30	600 - 700	100 - 250	-

Table 5: Mechanical properties of some thermoplastics

5.1.2 Tensile test

In the unidirectional tensile test conforming to DIN EN ISO 527 a test specimen with dimensions defined according to the method of manufacture is stretched to break at an optionally selectable velocity.

The maximum stress reached before the occurrence of flow is referred to as yield stress σ_y . The associated strain is called yield strain ε_y . The tensile stress at which break occurs is fracture resistance σ_b and the corresponding strain is elongation at break ε_b . The tensile stress at which the first stress peak occurs is referred to as tensile strength σ_m . Consequently, tensile strength σ_m can be either fracture resistance σ_b (amorphous thermoplastics in some cases) or yield stress σ_y (e.g. partially crystalline thermoplastics).

The short-term modulus of elasticity is determined from the slope of the stress-strain curve. The stresses are determined at strains of 0.05% and 0.25% and calculated from the quotient of the difference in stresses

($\Delta\sigma = \sigma_{0.25\%} - \sigma_{0.05\%}$) and the difference in strains ($\Delta\varepsilon = 0.25 - 0.05 = 0.2$) of the tangent modulus or secant modulus:

$$E = \frac{\sigma_{0.25\%} - \sigma_{0.05\%}}{0.2}$$

When conducting the test, it is important to ensure that specimens are prepared carefully because if they are clamped at an angle or if specimens are crooked, shear forces can act; this would usually alter the test result and supply lower values. Notches and dents in the surfaces of specimens can also have an adverse effect on the test result. To reduce the influence of clamping, the tensile specimen can be made with thickened pieces at the ends which absorb the compressive forces exerted by the clamping device. The same can be achieved by using shoulder rods.

Partially crystalline materials such as PE, PP and PVDF usually have a substantial yield point and high elongation at break (Figure 32), whilst amorphous thermoplastics such as PVC exhibit higher yield stress but lower tensile strength at break and elongation at break (Figure 33).

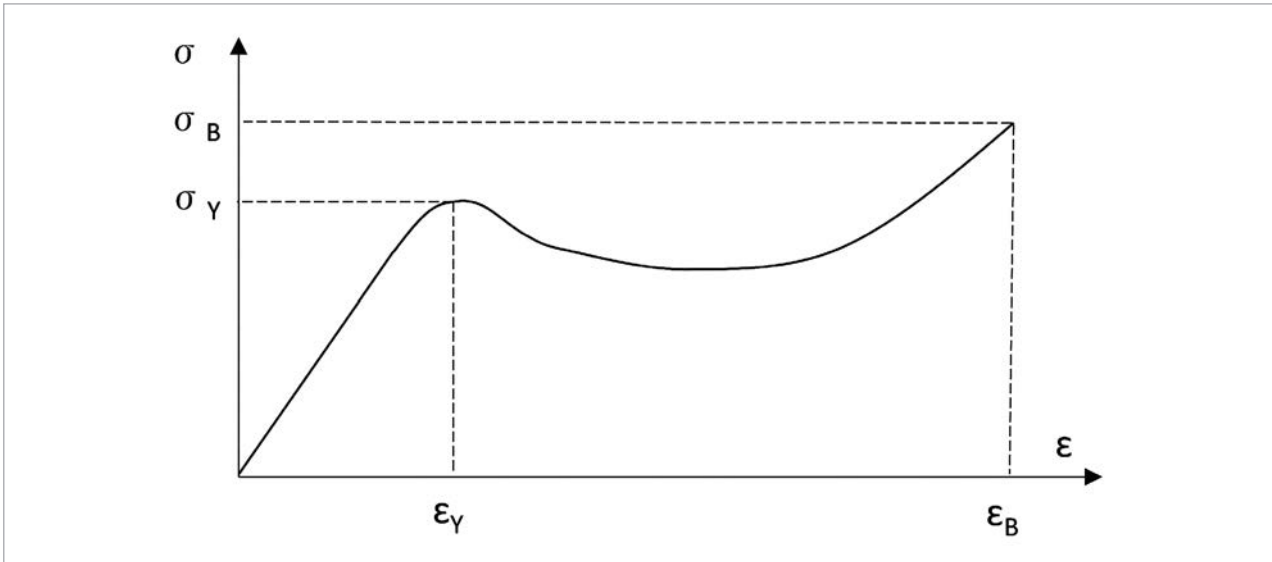

Figure 32: Diagram of the stress-strain curve of a partially crystalline thermoplastic

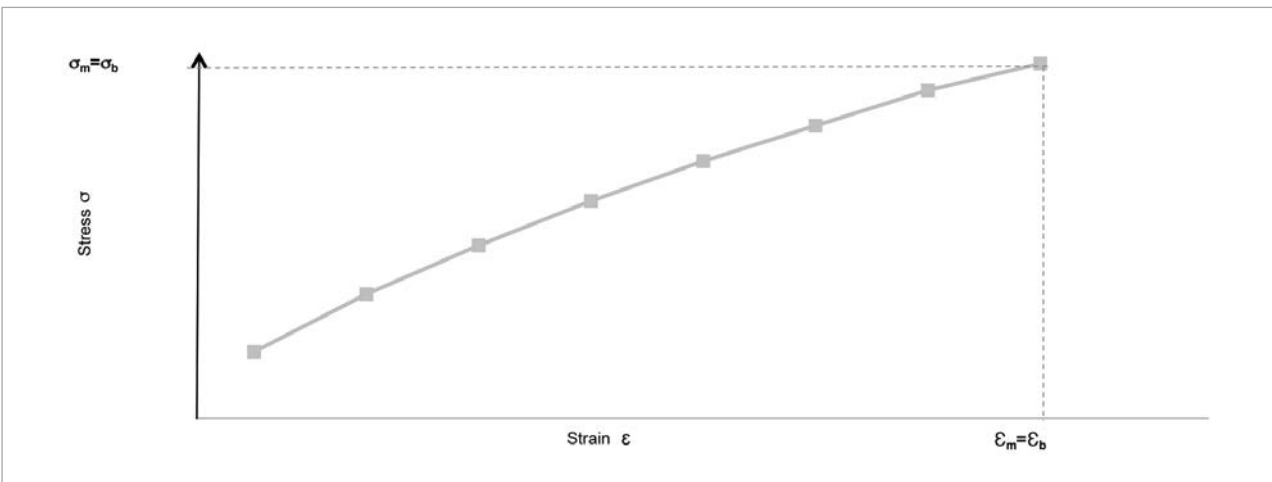

Figure 33: Stress-strain curve with tensile strength σ_y , tensile strength at break σ_b and the associated strains for amorphous thermoplastics

Figure 34 shows the shortterm modulus of elasticity of various SIMONA® thermoplastics in relation to temperature. This elementary chart indicates the high rigidity of

PVC at room temperature and the steep drop in modulus of elasticity above 60 °C.

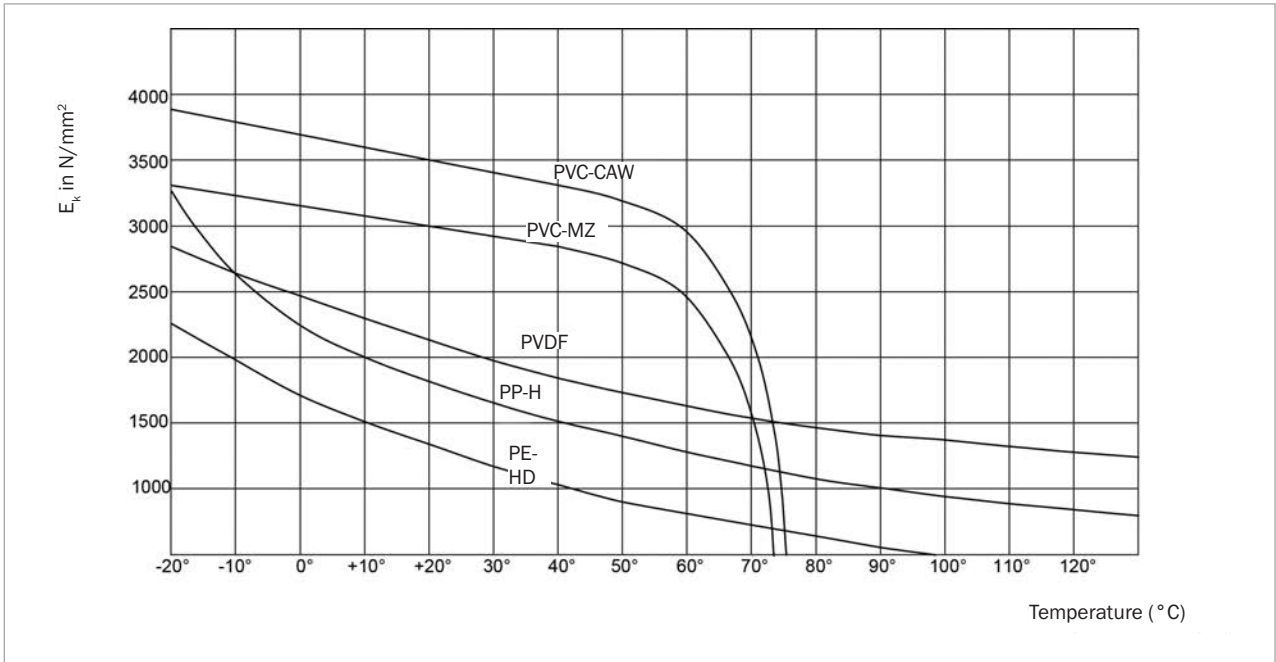

Figure 34: Short-term modulus of elasticity of SIMONA® thermoplastics in relation to temperature

5.1.3 Bending test

The 3- and 4-point bending test conforming to DIN EN ISO 178 and DIN EN ISO 14125 is the one most often used in engineering because the shape of test specimens is simple and the test is easy to perform. However, assessment and analysis of the stress-strain curve are slightly more complicated.

Bending stress σ_b is the quotient of bending moment M and bending resistance W :

$$\sigma_b = \frac{M}{W}$$

M is the product of force F and effective span l_v :

3-point bending:
$$M = \frac{F \cdot l_v}{4}$$

4-point bending:
$$M = \frac{F \cdot l_A}{2}$$

Whereby $2 l_A$ is the difference between the lower and upper effective span. The section modulus is the product of test specimen width B and test specimen height H :

$$W = \frac{B \cdot H^2}{6}$$

This provides the bending stress σ_b :

3-point bending:
$$\sigma_b = \frac{3 \cdot F \cdot l_v}{2 \cdot B \cdot H^2}$$

4-point bending:
$$\sigma_b = \frac{3 \cdot F \cdot l_A}{B \cdot H^2}$$

4-point bending:
$$\varepsilon = \frac{4 \cdot f \cdot H}{l_B^2}$$

The modulus of elasticity is calculated as follows:

$$E = \frac{\sigma_{b_2} - \sigma_{b_1}}{\varepsilon_2 - \varepsilon_1}$$

As in a tensile test, it is important to ensure careful test specimen preparation for a bending test because here too surface cracks have a considerable influence on the test result.

Whereby surface layer expansion is calculated by dividing deflection f by $l_B =$ upper effective span:

3-point bending:
$$\varepsilon = \frac{6 \cdot f \cdot H}{l_V^2}$$

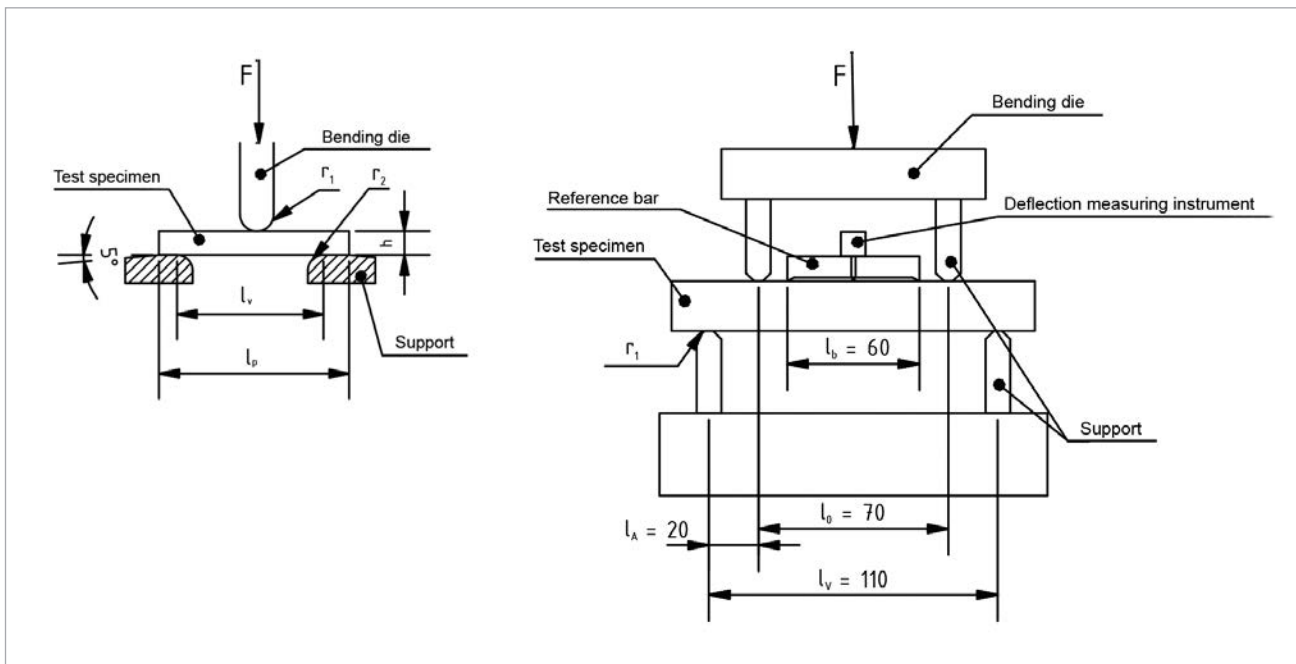

Figure 35: Diagram of a 3-point and 4-point bending test

5.1.4 Pressure test

The pressure test conforming to DIN EN ISO 604 is normally applied if the material used in practice is chiefly subject to a pressure load. The test specimens used are rectangular prisms, cylinders or tubes. To prevent the pressure surfaces from flaking off brittle plastics, they are inserted in so-called caps which support the material laterally. To be able to assess relatively thin workpieces such as sheets, shoulder rods are also used.

Testing takes place at a constant force rate or strain rate, which depends on the length of the test specimen. The calculation of compressive strength, modulus of elasticity and compressive strain is conducted in a similar way to that of the tensile test.

For test specimen preparation it is important to make sure the end surfaces are plane-parallel in order to avoid shear loads in conjunction with compressive strain. Brittle materials in particular react very sensitively to such loads, so the test result would be distorted.

5.1.5 Torsion pendulum test

With the aid of the torsion pendulum procedure conforming to DIN EN ISO 6721 the elastic, viscoelastic, energy-elastic and entropy-elastic properties of a material can be determined over a large temperature range.

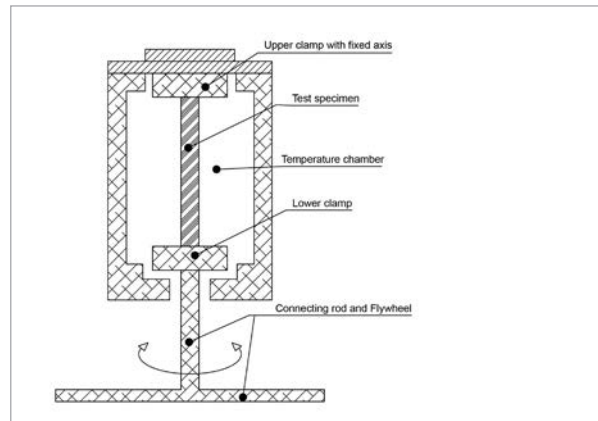

Figure 36: Torsion pendulum test

The test specimens can have a circular or square cross-section. They are clamped into the device at both ends; one end is connected to the flywheel.

At the beginning of measurement the flywheel is deflected by a certain angle α , which is kept small in order to prevent the test specimen from being overloaded. Now the system is allowed to swing freely and the oscillation amplitude A is recorded as a function of time t . The decrease in amplitude over time due to inner friction (damped vibration) produces the logarithmic decrement Λ by calculating the quotient of the amplitudes of two successive vibrations A_n and A_{n+1} :

$$\Lambda = \frac{A_n}{A_{n+1}}$$

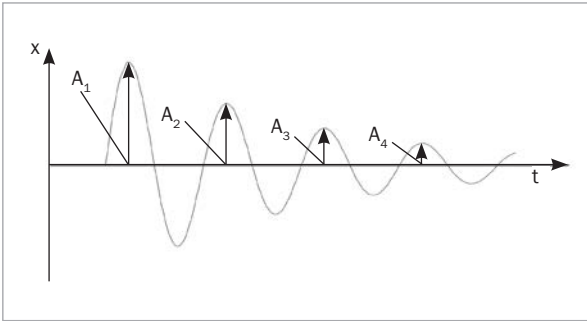

Figure 37: Damped vibration

The logarithmic decrement Λ is closely linked to damping d :

$$d = \frac{\Lambda}{\pi \cdot \left(1 + \frac{\Lambda^2}{4 \cdot \pi^2}\right)}$$

The moment of inertia I , test specimen length L , test specimen width b , test specimen thickness a and natural frequency f_0 , which is taken from the change in time on the vibration curve, are used to calculate shear modulus G :

$$G = 4 \cdot \pi^2 \cdot I \cdot f_0^2 \cdot \left(1 + \frac{\Lambda^2}{4 \cdot \pi^2}\right) \cdot \left(\frac{3 \cdot L}{b \cdot a^3 \cdot (1 - 0.63 \cdot \frac{a}{b})}\right)$$

$$\text{with } I = \frac{1}{2} \cdot m \cdot r^2$$

Whereby m is the mass and r the radius of the flywheel.

Since loss factor d equals the tangent of the phase angle δ , if G is known, storage modulus G' and loss modulus G'' can be calculated:

$$G' = G \cdot \cos \delta$$

$$G'' = G \cdot \sin \delta$$

The torsion pendulum test opens up many different options for characterising a material in greater detail and defining its limits. In test engineering it has become established practice to measure the dynamic properties in relation to temperature and excitation frequency. Those measurements are used to generate characteristic maps that describe the material more precisely.

One of the simpler variants is definition of the glass transition temperature T_g of plastics. For this purpose moduli G' and G'' are determined. Their point of intersection over the abscissa is referred to as glass transition.

5.1.6 Ring shear test and segment shear test

To measure the interlaminar adhesion or the adhesion of a liner to the reinforcement layer of a pipe, the ring shear test or the segment shear test is used in compliance with DIN 53769-1.

The ring shear test (Figure 38) uses a piece of pipe 30 mm long, one end of which is machined from the outside over a length of 5 mm up to the middle of the pipe wall or, in the case of a liner GRP pipe, up to the liner. The other end is machined in the same way but from the inside. Ring shear strength τ_R is calculated by dividing the measured failure force F by the adhesion area $2 \cdot \pi \cdot r \cdot h$:

$$\tau_R = \frac{F}{2 \cdot \pi \cdot r \cdot h}$$

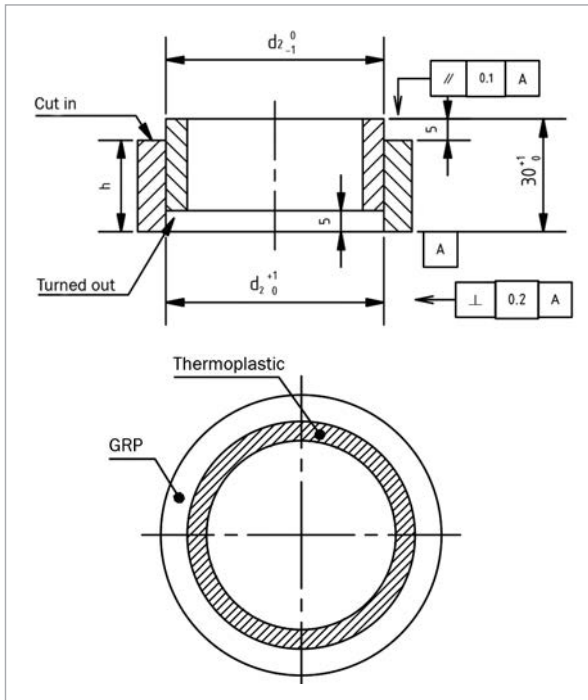

Figure 38: Ring shear test

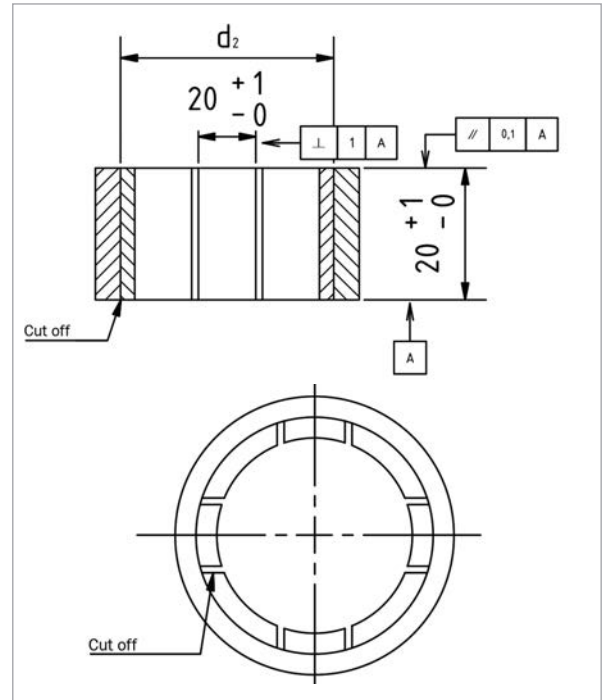

Figure 39: Segment shear test

In the segment shear test (Figure 39) only a segment of the pipe is tested. The segment is made by notching a piece of pipe 20 mm in length along the cylinder axis, thus creating segments with a width b .

With the aid of a die whose width is the same as the width of the segment the segment of the piece of pipe is subjected to pressure. The segment is positioned on the supporting surface in such a way that it can freely shear off downwards. Segment shear strength τ_s is then calculated as follows:

$$\tau_s = \frac{F}{b \cdot h}$$

5.1.7 Pull-off test

The pull-off test conforming to DIN 53766-1 makes it possible, inter alia, to assess the adhesive strength between the lining material and the supporting laminate. A test specimen with a diameter of 30 mm is glued or welded onto the appropriate pulling dies so that the cylinder axis of the test specimen is perpendicular to the laminate plane (Figure 40). This arrangement is then subjected to tensile testing up to break. Adhesive strength σ_h is calculated by dividing measured maximum force F_{\max} by area A_0 :

$$\sigma_h = \frac{F_{\max}}{A_0}$$

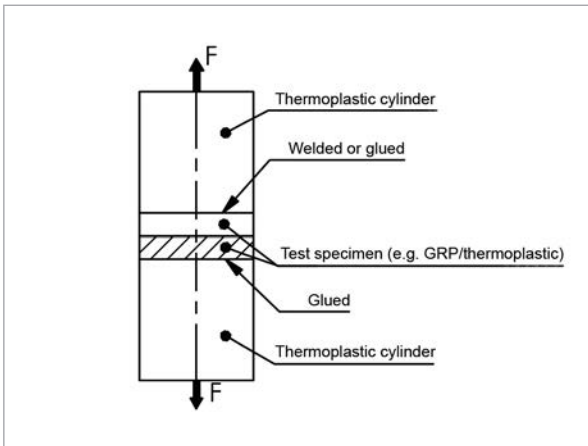

Figure 40: Test arrangement for measuring adhesive tensile strength (test specimen shape A)

5.1.8 Testing notched impact strength

Plastics are generally much more sensitive to impact and notching than other conventional materials such as steel. The term „sensitivity to impact“ characterises the various types of material behaviour during exposure to static loads (at rest) and impact loads. It refers to a force that acts on a body at high speed for a short time. The behaviour in the case of impact loads can be investigated by various test methods.

In Europe, the impact bending test conforming to DIN EN ISO 179 is used with the Charpy notch shape.

With the aid of a pendulum impact tester as per DIN 51222 the test specimen is subjected to a 3-point bending load caused by impact (Figure 41).

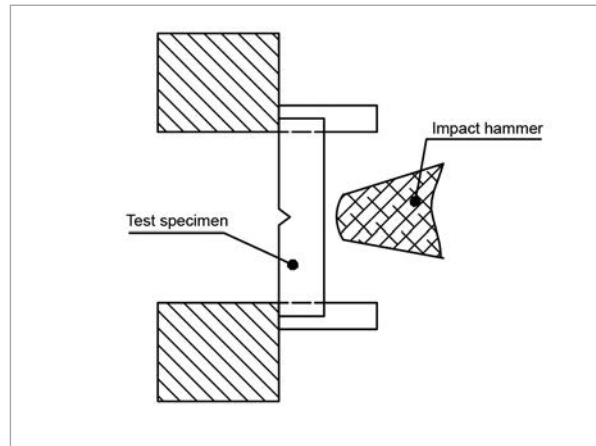

Figure 41: Charpy impact bending test

What is measured is the impact absorbed by the test specimen. A distinction is drawn between the specifications for impact strength and those for notched impact strength.

5.1.9 Testing impact strength

Impact strength is determined with the aid of an un-notched test specimen. Some SIMONA® materials do not break during this test (room temperature: 23°C). It is therefore impossible to state a figure for the work of fracture. That is why in the material specifications tables in Section 4 you will find the note „No break“. In such cases the notched impact strength described above is chiefly used for differentiation. The impact strength test, however, becomes especially meaningful when external influences such as ultraviolet light or chemicals cause embrittlement.

The dependency of impact strength and notched impact strength on temperature is of particular interest. At very low temperatures brittle fractures occur, whilst at higher temperatures the fractures are ductile. Consequently, based on temperature-dependent impact strength values

and notched impact strength values it is possible to make a statement about the lower service temperatures of the relevant material. This is particularly illustrated by the diagram in Figure 42.

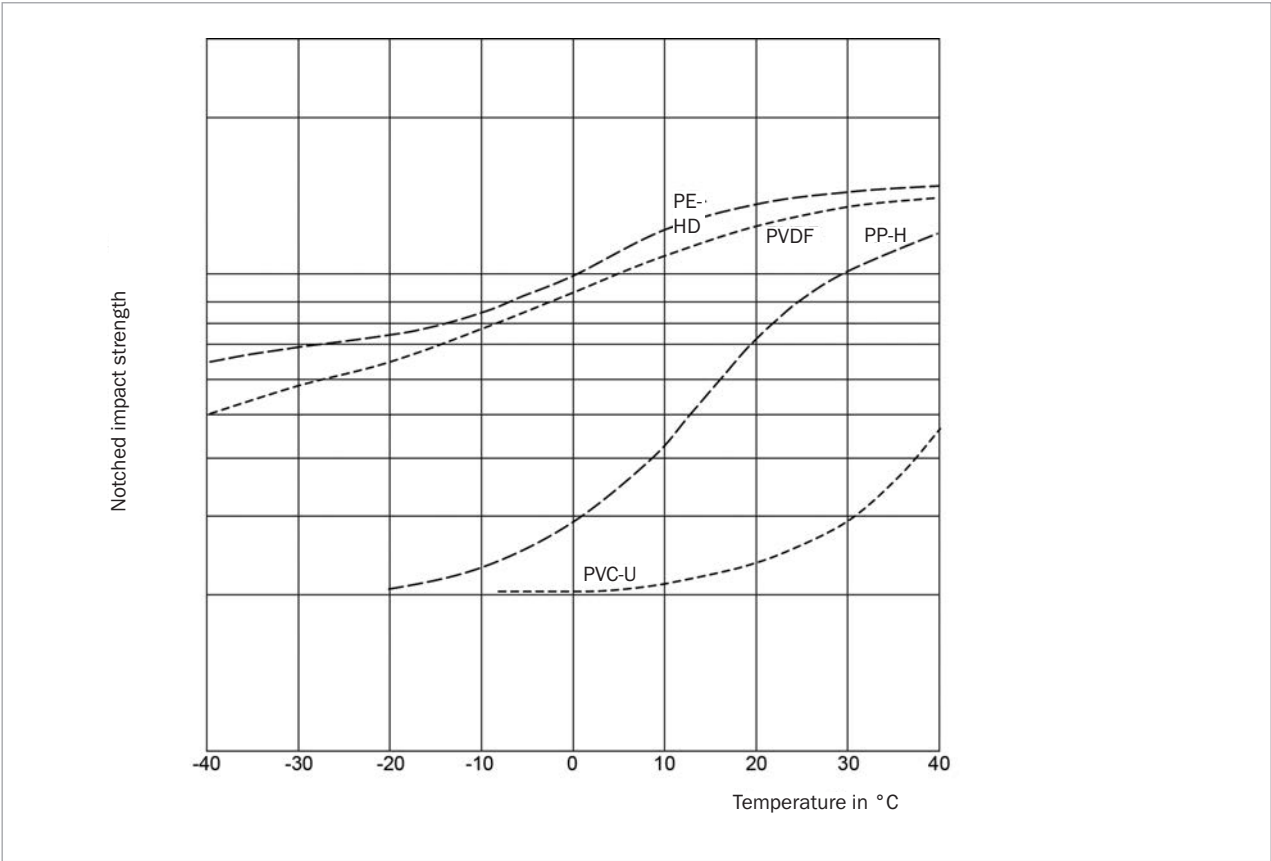

Figure 42: Notched impact strength as a function of temperature

- High notched impact strength values = high toughness
- Low notched impact strength values = high brittleness

5.1.10 Surface hardness

Static methods are normally used to investigate the surface hardness of a material. In a hardness test the resistance of a material surface to penetration by a harder body (steel ball, steel cone or diamond cone) is measured or the material displacement by the penetrated body is determined. The hardness of a material is a measure of its rigidity. In this context, hardness is determined outside the elastic material behaviour, so it cannot be correlated with the modulus of elasticity.

5.1.10.1 Ball indentation hardness H as per DIN EN ISO 2039-1

A ball ($d = 5 \text{ mm}$) presses on the material surface with a defined force for a period of 30 seconds. Ball indentation hardness is calculated by dividing test force F in N by surface area A in mm^2 of the indentation in the material surface:

$$H = \frac{F}{A}$$

5.1.10.2 Shore D hardness as per DIN EN ISO 868

The Shore test procedure is a fast and efficient way to determine the hardness of plastics and hard rubber. A pointed test specimen with a defined tip and force is pressed into the test material for a certain time.

The measuring instrument converts the resistance of the test specimen to penetration into the appropriate hardness values. Various test times can be applied for a test criterion. Depending on the material, two different types

of test specimen can be used: type A for soft materials and type D for harder ones.

SIMONA® materials are mainly tested according to the Shore D method. The duration of testing is 15 sec.

5.1.11 Wear properties

The definition of wear is the erosion of material from a surface by mechanical loads. The description of material erosion from a surface is highly complex: on the one hand it involves impulse transmission of particles hitting the surface and on the other it is associated with the adhesion properties of the surface. A distinction is therefore made between friction wear, jet erosion, sliding wear and cavitation wear. Wear also depends on whether the wear particles are dry or in a liquid when they act.

The test methods for determining the wear resistance of a material are just as numerous as the “types” of wear themselves. It should be pointed out that wear depends not only on the material but also on the test conditions. Consequently, any assessment of wear always has to take account of the tribological system, which comprises the material, the abrasive substance and the test parameters. Conventional test methods include the friction wheel test, the pin-on-disc test, the jet wear test and the sand-slurry test, to name just a few.

In the **friction wheel test** a flat, round plate rotates under two freely rotatable rollers covered with emery cloth. In DIN 53754 the contact force of the rollers is defined as being 5.4 N and the rotational speed of the plate is 55 min^{-1} . The amount of wear is determined from the reduction in mass or volume of the plate per unit of time.

The **pin-on-disc test** was developed in order to measure sliding wear and consists of a rotating friction plate, onto which the specimen in the form of a pin is pressed at a defined force. Again, the reduction in mass or volume is used as a measure of wear.

The determination of **jet wear** is conducted by blasting a specimen plate with particles of a defined size at a defined velocity. The advantage of this method is its scope for variation. For example, a liquid can be added to the abrasive in order to incorporate the effect of different lubricants. In addition, wear can be measured in relation to the angle of incidence. However, the dependence of wear on test duration is a drawback because as erosion increases a hole appears, the geometric properties of which have nothing in common with the flat plate.

The **sand-slurry test** consists of an abrasion test vessel containing a mixture of sand and water in a defined ratio, in which the test specimens rotate at a specified speed. Since the vessel is double-walled, the dependence of wear on temperature can also be determined. By selecting the wearing medium it is therefore possible to conduct highly practice-oriented tests on components through which substances flow, e.g. pipes.

According to relevant literature, wear μ_v is dependent on the mechanical and adhesive properties of a material. In terms of quality it depends on friction coefficient f , the modulus of elasticity, yield point σ_s and yield strain ε_s :

$$\mu_v \sim \frac{f}{E} \cdot \frac{1}{\sigma_s \cdot \varepsilon_s}$$

Friction coefficient f consists of an adhesive part f_{ad} and a deformative part f_{def} by addition.

The adhesive friction coefficient f_{ad} is a function of shear strength τ_s , contact pressure p , modulus of elasticity E and surface quality β :

$$f_{ad} = \frac{\tau_s}{p} \cdot \left[1 - \exp\left(\beta \cdot \frac{p}{E}\right) \right]$$

The deformative friction coefficient f_{def} is dependent on the mechanical properties of the abrasive Γ , contact pressure p , the modulus of elasticity and the loss factor $\tan \delta$ of the test specimen:

$$f_{def} = \Gamma \cdot \frac{p}{E} \cdot \tan \delta$$

This makes it clear that the wear of a material depends on $1/E^2$ by first approximation:

$$\mu_v \sim \left(\frac{\tau_s \cdot \beta \cdot p}{E^2} + \frac{\Gamma \cdot p \cdot \tan \delta}{E^2} \right) \cdot \frac{1}{\sigma_s \cdot \varepsilon_s}$$

Wear resistance is thus raised by a factor of 4 if the modulus of elasticity drops by half. Yield point σ_s and yield strain ε_s , on the other hand, only have a linear effect on wear. The consequence of this is that since the elongation at break of thermoplastics (e.g. PE) is 200 times higher the latter have less wear than thermoset plastics and some grades of steel.

5.1.11.1 Sand-slurry test

When it comes to simulating wear in pipelines with water-solid mixtures subject to turbulent flow conditions the sand-slurry test is considered relatively suitable. It does not place high demands on the experimental setup but nevertheless provides sufficiently accurate differentiation between various thermoplastics.

The experimental arrangement for this test (Figure 43) comprises parallel rows of adjacent wear containers made of chrome nickel steel, which are filled with a slurry consisting of two parts by weight of water and three parts by weight of silica sand, with grain sizes between 0.5 mm and 1.5 mm. In the container, cuboid-shaped test specimens rotate at a constant speed for 24 hours. Process temperature can be freely selected between 20 °C and 80 °C. For low measuring temperatures, e.g. 20 °C, the heat generated by rotation of the test specimens in the wear pots is dissipated by cooling. In addition, the apparatus is provided with thermal insulation in order to ensure a constant temperature of up to 80 °C.

Wear resistance is heavily dependent, inter alia, on the molecular weight of the polymer material. As molecular weight rises, the wear resistance of the material increases. Of all SIMONA® semifinished products SIMONA® PE 1000 has the highest level of wear resistance.

The test apparatus of the sand-slurry test makes it possible to investigate the influence of temperature on wear behaviour. In this context it was found that as temperature rises the wear resistance increases considerably (Figure 44) because although thermoplastics become softer as temperature rises (declining modulus of elasticity) the elongation at break and the damping show a disproportionate increase.

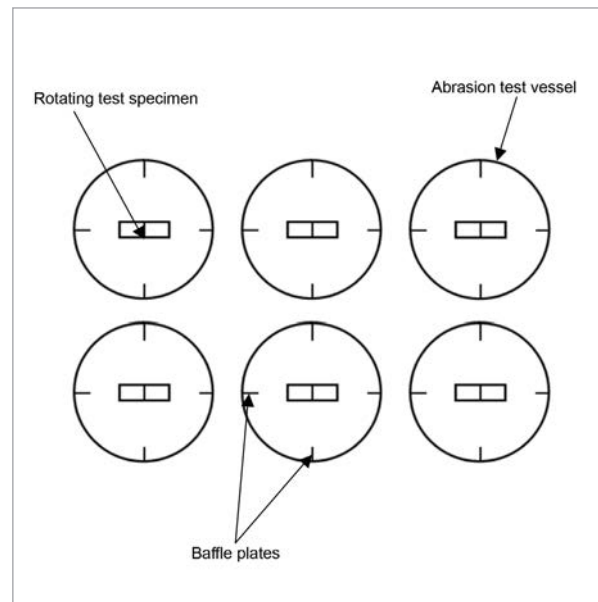

Figure 43: Basic setup of the sand-slurry test

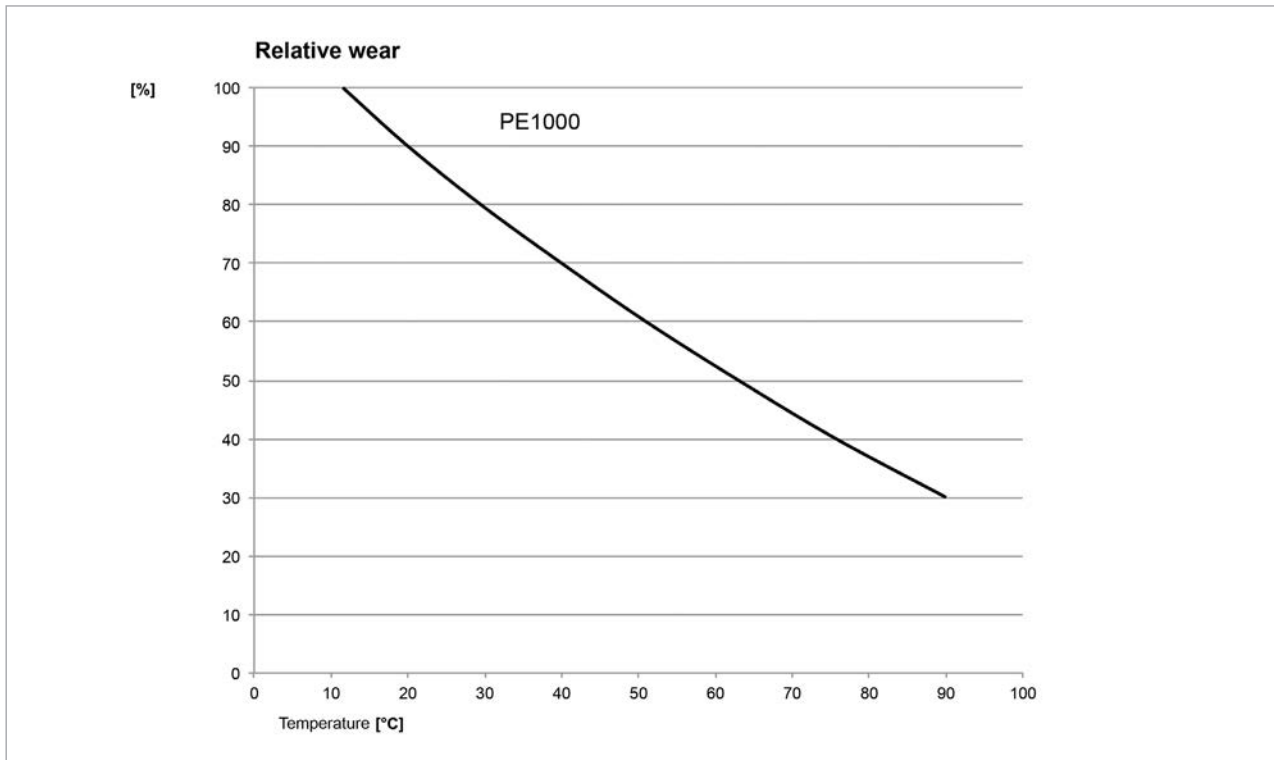

Figure 44: Relative wear of thermoplastics as a function of temperature

5.2 Thermal properties

5.2.1 Thermal conduction

Thermal conduction refers to a process in which heat within a material is transported from location A to location B.

The heat is always conducted from high-temperature zones to low-temperature zones. If heat exchange between the zones can proceed without any disturbances, it takes place until the deficit has been compensated and the body has a uniform temperature.

Heat, which constitutes a form of energy, is transported at the speed of sound, which is specific to the material and is dependent on the modulus of elasticity and density.

Owing to the low density, the low speed of sound and the low thermal capacity compared to that of metals (thermal capacity increases as electrical conductivity rises), pure plastics are generally bad heat conductors and consequently good thermal insulators.

	Material	Thermal conductivity λ [W/(m · K)]
Plastics	Polyethylene, PE	0.50
	Polyamide, PA	0.30
	Polyurethaen, PU	0.25
	Polypropylene, PP	0.23
	Polyvinyl chloride, PVC	0.17
Metals	Silver	429
	Copper, pure	400
	Aluminium, pure	236
	Brass	120
	Iron	80

Table 6: Thermal conductivity λ of some materials

5.2.1.1 Heat capacity

Heat capacity c is stated in J/K and it indicates by how many degrees C or K the temperature of a body rises when it receives a certain amount of heat.

Specific heat capacity C describes the ability of a body to store heat. It indicates how much heat a material absorbs or emits during a change in temperature. The unit of measure is J/(kg·K). Specific heat capacity is a material-specific property but it is dependent on various parameters, e.g. temperature. For this reason, the specific heat capacity of a material is often stated for a certain temperature.

5.2.1.2 Thermal conductivity

Thermal conductivity λ , which is also referred to as the heat transfer coefficient, is a temperature-dependent specification that numerically indicates the ability of a material to transport heat internally. It is stated in W/(m·K). Thermal conductivity can be improved with the aid of fillers, provided they have a higher level of thermal conductivity. Carbon dust, graphite, metal fibres or metal powder are often used for this purpose.

If the fillers have anisotropic thermal properties and the ability to orient themselves in the material, the filled plastic also acquires anisotropic thermal properties. This can, for example, be observed in plastics that are filled with graphite. Graphite is thermally anisotropic and owing to the platelet shape and manufacturing conditions it often orients itself in the direction of flow within the material.

5.2.2 Heat transfer

To calculate the transmission of heat through a wall, it is necessary to know not only the thermal conduction but also the heat transfer coefficient inside and outside the wall as well as the thermal transmittance.

Heat flow j is calculated as follows:

$$j = U \cdot A \cdot \Delta T$$

where

- U = thermal transmittance
- A = area of the wall
- ΔT = temperature difference

Thermal transmittance U (also referred to as the k-value) is calculated as follows:

$$U = \frac{1}{1/\alpha_i + s/\lambda + 1/\alpha_a}$$

where s = wall thickness
 λ = thermal conductivity
 $\alpha_{i,a}$ = heat transfer coefficient inside,
 outside

Heat transfer coefficient α determines the transmission of heat to a wall and depends entirely on the type and velocity of the medium being conveyed. It is completely independent of the material of the wall. The higher the thermal transmittance, the poorer the thermal insulation property of the material. Vice versa, the lower the thermal transmittance, the better the thermal insulation property, and the higher the heat transfer resistance. Thermal transmittance has the unit of measure $W/(m^2 \cdot K)$.

5.2.3 Thermal expansion

When materials are exposed to a change in temperature, they alter their dimensions such as length, width and height, and consequently their volume. Since in the event of a temperature change the mass of the body remains the same but the volume alters, there is also bound to be a change in the density of the material. When a material is warmed it expands and when it cools down it contracts.

The cause of the dimensional change is explained by the oscillation of the atoms in the material and a point of equilibrium around them. As temperature rises the oscillation increases in amplitude and the material

expands. Although the coefficient of linear expansion is a substance-specific material constant, it is temperature-dependent (Figure 45) and increases as temperature rises so the volume of the body undergoes a disproportionate change as temperature rises. The coefficient of linear expansion is often averaged over the application temperature range and stated as the „mean thermal coefficient of linear expansion“.

Since the thermal coefficient of linear expansion depends on the bonding characteristics within a material, it can be linked to the elastic properties and the melting point.

The length L of a rod increases in proportion to temperature T according to the following relationship:

$$L = L_0 \cdot (1 + \alpha \cdot T)$$

Here, L_0 refers to the length of the rod at $T = 0$ K. If the plastic is mixed with fillers or fibres, the simple mixing rule generally produces the coefficient of expansion α_c of the filled plastic:

$$\alpha_c = \alpha_k \cdot (1 - \varphi_k) + \alpha_f + \varphi_f$$

Here, α_k and α_f are the coefficients of expansion of the plastic and the filler whilst φ_k and φ_f are the volume fractions of the plastic and the filler.

Typical mean thermal coefficients of expansion can be seen from the following table:

Material	α [$10^{-6}/K$]
Glass	4
Steel	12
Copper	18
Aluminium	24
Polypropylene	160
Polyethylene	180
PVDF	120
ECTFE	80
PVC	80
GRP	20 - 30
CFRP	0 - 20

Table 7: Mean thermal coefficient of expansion for some materials

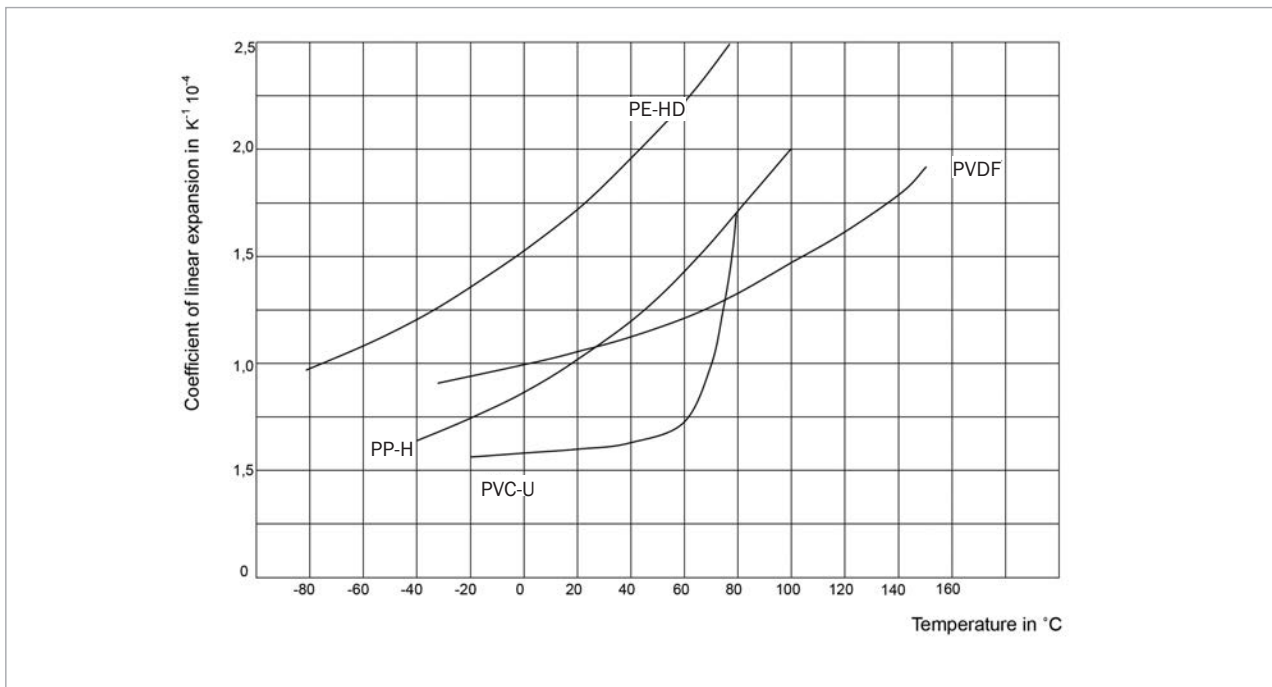

Figure 45: Thermal coefficient of linear expansion as a function of temperature for some thermoplastics

5.2.4 Heat distortion temperature test

As opposed to thermoset plastics, the properties of thermoplastics are very heavily dependent on temperature. At high temperatures thermoplastics change to the plastic state. That is why it is extremely important for a design engineer or processor of thermoplastics to obtain an approximate figure for the temperature limit of the dimensional stability of a material. However, the temperatures determined in those tests must not be regarded as maximum service temperatures because, for example, mechanical properties are not taken into consideration.

For a heat distortion temperature test on plastics two methods are chiefly used:

1. Vicat (DIN EN ISO 306)
2. Heat distortion temperature (HDT) (ISO 75)

We can determine the heat distortion temperature of our thermoplastics by both methods.

The Vicat temperature is the temperature at which the Vicat needle (tip with a cross-sectional area of approx. 1 mm²) has penetrated the material by 1 mm under a certain load and at a defined heating rate.

When determining the heat distortion temperature (HDT) a test specimen is placed upright on two supports in an oil bath. At the centre between those two supports the test specimen is subjected to a load with a defined force. The oil bath is heated up at a certain heating rate. The temperature at which the test specimen has a deflection of 1 mm is read and stated as HDT.

5.3 Fire rating

According to DIN 4102, a distinction is drawn between non-combustible building materials (Class A) and combustible building materials (Class B). Plastics are classified in the latter group without exception.

Class B is subdivided into:

- B 1 low flammability
- B 2 normal flammability
- B 3 high flammability

To comply with fire protection codes, for public buildings, trade fairs, etc., Germany specifies materials that meet the low flammability requirements (B1) of DIN 4102.

5.3.1 Fire test as per DIN 4102

For building materials with the exception of wall linings and floor coverings, which are dealt with separately in DIN 4102, the B1 test basically illustrates fire for an object in the corner of a room. For this purpose the heat emission to the room and the spread of fire must be restricted. A B1 test takes place in a fire shaft. The latter has a square cross section and a total height of approx. 2,500 mm. To each side of the square fire shaft a test specimen is attached vertically at a certain height in such a way that the distance between the test specimen and the square burner, which is located below the test specimens, is 25 mm ± 1 mm. Flame impingement takes place for a period of 10 minutes. An analysis of the test assesses, inter alia, the remaining residual length of the test specimens, any dripping behaviour and the mean flue gas temperature. In this context certain limits must not be exceeded.

A B1 test for building materials is regarded as passed if that fire shaft test has been passed and the requirements for B2 (constitutes the load, e.g. due to a match flame) have been fulfilled.

The ability to pass the fire shaft test decreases as sheet thickness increases, assuming identical material.

Another assessment criterion is the oxygen index (LOI = Limiting Oxygen Index, DIN EN ISO 4589). This figure states the minimum oxygen concentration in an oxygen-nitrogen mixture where burning is being maintained. This

means that only for an oxygen demand of $\leq 20.8\%$ (level of oxygen in the atmosphere) ignition is brought about with the aid of an ignition source and continued burning is possible when that ignition source has been removed.

Table 8 lists the oxygen indices and fire rating classifications that were determined by various test methods:

- DIN 4102 in a fire shaft installation
- DIN 53438 with edge (K) and area (F) flame impingement
- UL 94 (US test standard)

Material	Fire rating to DIN 4102 Class*	Oxygen index to ASTM 2863	Rating to UL 94 Class*	Rating to DIN 53438 Class	
PE-HD	B2	18			
PE-EL	B2	18			
PP-H	B2	18			
PP-B	B2	18			
PPs	B1	28		F1	K1
PVC	B1	40	V0		
PVDF	B1	60	V0		
ECTFE	B1	52			

* For details on the availability of test certificates, see Section 4.

Table 8: Assessment of fire behaviour

5.3.2 SBI test as per DIN EN 13823

The SBI test (Single Burning Item) is a new test that has been introduced to the European area and it will replace the national fire tests after a transitional period that still has to be decided on. At the time when this Technical Handbook was written there was no requirement regarding SBI for construction products on the Building Rules List issued by DIBt (German Institute of Building Technology).

DIN EN 13823 describes the fire rating tests for construction products whilst DIN EN 13501-1 deals with the classification of construction products and types with regard to their fire behaviour. The latter is applied to three categories of construction products, which are dealt with separately:

1. construction products with the exception of floor coverings and pipe insulations,
2. floor coverings and
3. pipe insulations.

The test basically assesses what contribution a certain construction product makes to a developing fire. In this context it is assumed that the fire is triggered by a burning object standing in a corner, as illustrated in Figure 46.

The test consists of two walls 0.5 m x 1.5 m and 1.0 m x 1.5 m, which are at right angles to one another and positioned in metal frames.

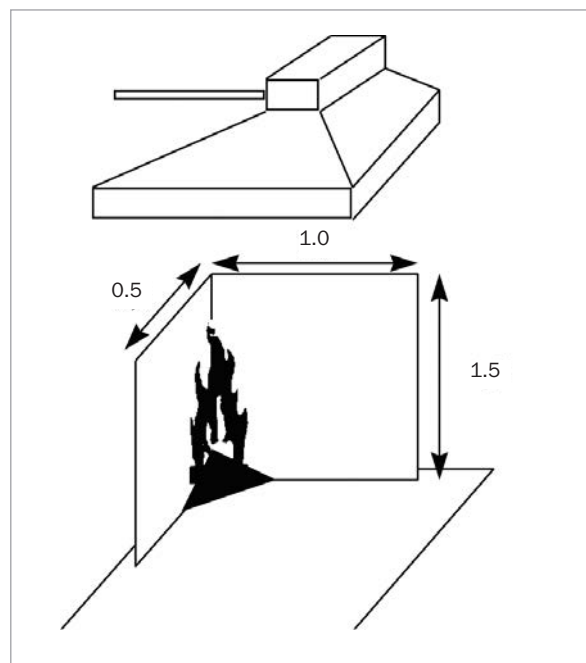

Figure 46: Diagram of the SBI test

During the test, calorimetric measurements and data from the flue gas are recorded and the records are used to make the classifications listed in DIN EN 13501-1.

DIN EN 13501-1 lists a total of seven fire classes for grading the various construction products. Classes A1 and A2 solely apply to non-combustible materials. For combustible construction materials classes B, C, D, E and F were created.

Important parameters for products that are classified in the SBI test:

- fire growth rate (FIGRA)
- total heat release (THR)
- lateral flame spread (LFS)
- smoke growth rate (SMOGRA)
- total smoke production (TSP)
- development of burning droplets/particles dripping off

For classes B to D all of these criteria are defined in greater detail. For class E, which has to be regarded as the SBI test entry level, only the small flame test conforming to EN ISO 11925-2 has to be passed (comparable with DIN 4102 B2). If a product fails to meet class E, it is not possible to conduct any further SBI test. In class F no criteria have to be met. The construction product is also placed in class F if class E is not achieved.

Smoke growth rate SMOGRA is divided into three grades:

- s1 = $SMOGRA \leq 30 \text{ m}^2 \cdot \text{s}^{-2}$, $TSP \leq 50 \text{ m}^2$
- s2 = $SMOGRA \leq 180 \text{ m}^2 \cdot \text{s}^{-2}$, $TSP \leq 200 \text{ m}^2$
- s3 = meets neither s1 nor s2

The occurrence of burning droplets dripping off is also characterised in three grades:

- d0 = no burning droplets within 600 s
- d1 = no burning droplets for more than 10 s within 600 s
- d2 = neither d0 nor d1

If in the small flame test the paper is ignited by burning particles dripping off, that product must automatically be classified as d2. However, the product has then also failed the small flame test and is automatically placed in class F. A major change of the SBI test in relation to national test methods was to be the introduction of a test for products and their ultimate applications. Most of the otherwise usual tests focused on the classification of materials. It should also be borne in mind that products that have so far been successful on the market without any apparent safety defects and were classified as usable may continue to be used in those applications. Irrespective of any reservations, after the introduction of the SBI test it will be necessary to retest and reapprove all products that have so far been used as construction products with special fire properties.

5.3.3 Fire test as per FM 4910

The semiconductors industry, in particular, has established exacting standards in respect of fire protection, simply because production outages can cause significant costs. Factory Mutual Global is a US-based industrial insurer that investigates whether plastics with a low fire load can be used as structural materials in the semiconductors industry.

The fire load is determined in a so-called small scale test. It consists of a special oven (glass tube) in which the test specimens are burned. The resulting gases are analysed during the fire and are used to assess the plastic. The criteria are as follows:

- propagation index (Fire Propagating Index), $FPI \leq 6$
- smoke production (Smoke Damage Index), $SDI \leq 0.4$
- corrosive action (Corrosion Damage Index), $CDI \leq 1.1$

Many manufacturers of semifinished parts are obliged to produce evidence of the suitability of their semi-finished product in accordance with FM 4910 so that the material can be used in cleanrooms in the semiconductors industry.

SIMONA AG is in possession of certification for PVDF pipes, fittings, sheets and welding rods as well as for CPVC sheets made of an FM 4910-certified raw material.

5.3.4 Fire tests as per UL 94

Within the US market the tests that apply are those conforming to the UL 94 standard. UL stands for the test laboratory Underwriters Laboratories. Accordingly, the fire properties of plastics are examined and assessed under various conditions.

In test UL 94 HB (HB= Horizontal Burning) the burning rate is determined over a certain distance depending on the sheet thickness of a plastic test specimen clamped horizontally. In test UL 94 V (V= Vertical) the test specimen, which is clamped vertically over a cotton swab, is subjected to flame impingement for 2 x 10 seconds. What is measured is the afterburning time following flame impingement, the total afterburning times (10 test specimens), the afterburning and afterglowing, possible dripping and the quantity of burned material. Depending on the result, the plastic is placed in class V0 (highest requirement), V1 or V2 (lowest requirement). If, during the test, burning material drips and if the cotton wool underneath is ignited, that material no longer qualifies

for class V0 or V1, no matter what the other measurements are. As opposed to the DIN 4102 B1 fire test, the ability of the material to reach UL 94 V0 rises as the wall thickness of the material increases. For this reason the test is regarded as having been passed for all thicknesses of the same material that are above the tested material thickness. If, for example, a test specimen of 1 mm thickness qualifies for class V0 according to the UL 94 V test, the test certificate shows ≥ 1 mm for material thickness.

If the plastic reaches at least classification UL 94 V2, further tests, and also classifications, can be conducted, such as:

- **5VB:** 5 times flame impingement for 5 seconds each on a test specimen clamped vertically; no dripping is permissible
- **5VA:** as for 5VB, with an additional test on the test specimen clamped horizontally; neither dripping nor the formation of fire holes with a diameter of > 1 mm is permissible

Since the test setup for classification according to DIN 4102 differs from that of UL 94, a general statement such as „if the material passes B1, it will also pass UL 94 V0“, or vice versa, is neither possible nor permissible. The same also applies to fire tests in other countries if they have their own test specifications.

5.4 Permeation

Owing to their low density, plastics are relatively permeable to gases and liquids compared with metals and minerals. Material transport through a membrane is referred to as **permeation**. In this context, a membrane is a layer that offers significant resistance to the transport of a gas or liquid. Permeation is made up of adsorption, absorption, diffusion and desorption. **Adsorption** is the attachment of a substance to the surface of a membrane. If gases or liquids do not solely move to the surface of a membrane but also dissolve in the membrane, this is referred to as **absorption**. **Diffusion** describes the transport of a substance through the membrane to the opposite boundary surface. **Desorption** is the reverse of adsorption and means the emission of a substance from the membrane surface to the environment.

Adsorption can be described for small concentrations and monomolecular layers based on the **Henry isotherm**, in which the quantity adsorbed at the surface, c , is proportional to partial pressure p of the adsorbent:

$$c = S \cdot p$$

where S = sorption constant

For higher concentrations the **Langmuir isotherm** is used.

$$c = \frac{S \cdot p}{1 + S \cdot p}$$

The quantity that a material can absorb depends on the chemical structure of the material. However, plastics in particular tend to absorb especially solvents to a large extent, as a result of which they swell.

Diffusion is described with the aid of the 1st and 2nd Fick's law. The **1st Fick's law** states that mass current density $j = dm/dt$, i.e. the mass of the particles, m , that diffuses through a constant area A per time unit rises when the concentration gradient dc/dx increases:

$$j = D \cdot A \cdot \frac{dc}{dx}$$

The constant D is referred to as the diffusion constant.

The **2nd Fick's law** states that the temporal change in concentration dc/dt is proportional to the local change in mass current density dj/dx :

$$\frac{dc}{dt} = D \cdot \frac{dj}{dx}$$

If concentration difference Δc prevails between the two sides of a membrane with a thickness $dx = s$ and an area A , a mass current diffuses through the membrane:

$$\frac{\Delta m}{\Delta t} = D \cdot A \cdot \frac{\Delta c}{s}$$

If one now substitutes c by pressure difference $\Delta p = p_2 - p_1$ between the membrane and introduces permeation constant $P = D \cdot S$, the result is:

$$\frac{\Delta m}{\Delta t} = P \cdot A \cdot \frac{\Delta p}{s}$$

P is then calculated as follows:

$$P = D \cdot S = \frac{\Delta m \cdot s}{A \cdot \Delta t \cdot \Delta p}$$

Diffusion, sorption and consequently also permeation are a function of temperature and obey the Arrhenius relationship:

$$D = D_0 \cdot \exp\left(\frac{-E_D}{R \cdot T}\right)$$

$$S = S_0 \cdot \exp\left(\frac{-E_S}{R \cdot T}\right)$$

$$P = P_0 \cdot \exp\left(\frac{-E_P}{R \cdot T}\right)$$

R in the above formulas is the general gas constant. Constants D_0 , S_0 and P_0 are material constants; they are usually independent of temperature T, activation energies E_i (i = D, S, P) and the concentration c of the absorbent in the membrane. The characteristic feature of the above calculation of permeation equilibrium is the fact that absorption is neglected because the analysis assumes a stationary equilibrium.

In elastomers, however, diffusion is dependent on concentration c, so the above equations no longer apply in this simple form for lengthy periods.

Experimental determination of permeation constant P can be conducted by measuring the mass that permeates through the membrane as a function of time t.

If there are multiple foils behind one another, the resulting permeation coefficient P can be calculated as follows:

$$\frac{1}{P_{ges}} = \frac{1}{S_{ges}} \cdot \sum_{i=1}^n \frac{S_i}{P_i}$$

- n = number of layers
- S_{ges} = total thickness of the membrane
- S_i = thickness of the i-th individual layer
- P_i = permeation of the i-th layer

5.5 Water absorption

The materials PE, PP, PVDF and ECTFE are water-repellent. Swelling, and hence a change in dimensional stability, does not take place. During 24-hour immersion in water in accordance with DIN 53495 only a slight amount of water absorption is detected (< 0.1% by mass).

In the case of PVC the water absorption during immersion in water is slightly higher. There is no change in dimensions. The mechanical values only change slightly. This is of no consequence for most applications.

However, care must be taken when welding or thermoforming if the material to be processed has absorbed moisture. The moisture absorption hazard rises with the length of storage and with the carbon content of the material (e.g. PE-EL). When heating materials that have absorbed moisture, blistering can occur during processing (welding or thermoforming). If this occurs, the problem can be remedied by drying the welding rod or the semifinished product.

5.6 Electrical properties

5.6.1 Electrical conductivity

Plastics are not only good thermal insulators but also good electrical ones. The specific resistance, which can be calculated according to Ohm's law $R = U/I$ (R = electrical resistance, U = voltage, I = current), is 10^{10} to 10^{20} $\Omega\text{-cm}$ for plastics. It is interesting to note that owing to polarisation processes the resistance of a plastic continuously changes towards lower levels in the course of time. For this reason the value of surface resistance in accordance with DIN IEC 60093, para. 10.2, is read one minute after applying the DC voltage.

In some special applications, however, at least a low electrical conductivity is desirable. It is often a case of discharging static in explosion-proof rooms. Here too, as in the case of thermal conductivity, it is possible to improvise by adding electrically conductive fillers. However, the quantity added must be large enough to create contact between the individual filler particles so that current can flow through them. Also, care must be taken to ensure that the fillers have external contact. If that external or internal contact is not guaranteed, electrical conductivity is only achieved at relatively high voltages at which the dielectric strength of the plastic layers between the environment and the filler or between the fillers is exceeded. Suitable fillers include all electrically conductive materials such as graphites, carbons and metals. However, conductive pigments are also available within the market to an increasing extent. They are made of minerals that are coated with metallic or semiconductive materials. However, they are often only suitable for thin layers such as coatings.

5.6.2 Dielectric properties

If one considers a plate capacitor (Figure 47) that consists of two metal plates set up parallel to one another, it can be charged by applying a voltage. The charge Q stored in the capacitor is proportional to the applied voltage U :

$$Q = C \cdot U$$

Constant C is referred to as capacitance and it is proportional to plate area A and inversely proportional to plate distance d :

$$C = \epsilon_0 \cdot \frac{A}{d}$$

Constant ϵ_0 is referred to as the dielectric constant of the vacuum. It is $8.9 \cdot 10^{-12} \text{ A} \cdot \text{s} \cdot \text{V}^{-1} \cdot \text{m}^{-1}$.

If there is a material between the plates, a „dielectric“, the capacitance of the capacitor changes according to the dielectric properties of the material:

$$C = \epsilon_0 \cdot \epsilon_r \cdot \frac{A}{d}$$

Constant ϵ_r is referred to as relative permittivity and it is the quotient of the capacitance with dielectric $C_{\text{Dielectric}}$ and the capacitance in the vacuum C_{Vacuum} :

$$\epsilon_r = \frac{C_{\text{Dielectric}}}{C_{\text{Vacuum}}}$$

With a dielectric the capacitance of a capacitor usually increases, i.e. for a large number of materials ϵ_r is greater than 1.

If the power source is disconnected from the capacitor, the total charge remains constant owing to the conservation of energy and the voltage that has to be measured across the capacitor plates decreases when there is a dielectric between the plates.

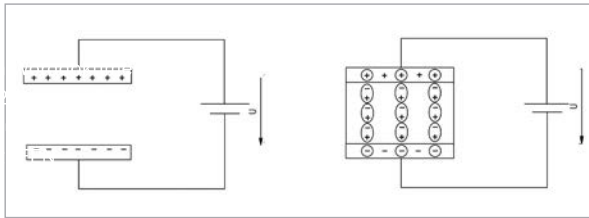

Figure 47: Capacitor arrangement with polarisation charges; a) without dielectric; b) with dielectric

The reason for this phenomenon can be explained by the atomic structure of many substances. Owing to chemical bonds, many substances have permanent or induced electric dipole moments. These dipole moments, which are also referred to as polarisation charges, can be oriented in an electric field, like one that prevails inside a capacitor. In such a case this is called the polarisability of the dielectric. The dipoles now orient themselves as a result of the electrical influence such that at the capacitor plates there are opposite charges and the electric field inside the capacitor is reduced by a factor of $1/\epsilon_r$.

Relative permittivity is important whenever a material has to be used in a high-frequency field. On account of alternating fields the dipole moments in the electric field are moved (polarity reversal) and the dielectric becomes warm. As with mechanical damping, relative permittivity is therefore represented in a complex way:

$$\epsilon_r = \epsilon_r' + i\epsilon_r''$$

Dielectric constant ϵ_r' refers to the reversible fraction and ϵ_r'' refers to the irreversible fraction of damping. On the current-voltage characteristic of a lossless capacitor the voltage leads the current by 90° . With dielectric loss the voltage only leads the current at an angle of $\varphi = 90^\circ - \delta$. The value $\tan \delta$ is called the loss factor and it obeys the following relationship:

$$\tan \delta = \frac{\epsilon_r''}{\epsilon_r'}$$

Since the dielectric loss factors of many unfilled plastics are below 10^{-3} , they are ideal for electrical insulation in the high-frequency range.

5.6.3 Dielectric strength E_d in accordance with DIN 53481 / VDE 0303-1

On account of frequent applications in the electrical engineering sector it is particularly important to make a statement about the ability of a material to ensure electrical insulation up to a specific AC voltage before the material is damaged beyond repair.

The dielectric strength is the ratio of breakdown voltage U_d (voltage that damages the test material beyond repair) to test specimen thickness. Consequently, breakdown voltage and dielectric strength are specific material properties. They are also dependent on test specimen thickness, ambient temperature, atmospheric pressure and the rate of voltage increase. The relationship between plate thickness and dielectric strength is non-linear.

5.6.4 Electric tracking resistance in accordance with DIN 53480 / VDE 0303-1

When deploying unmodified thermoplastics for electrical engineering applications (e.g. in electrical control cabinet manufacture) soiling cannot be ruled out in those cases in which there is constant usage. This can lead to the development of creepage on the surface of the insulation material. Visible signs of such currents are so-called tracks, which can occur as a result of thermal decomposition of the moulding involved (charring or wave-like electrical erosion). Tracking resistance is the resistance of the particular material to tracking.

5.6.5 Static

Within many fields of application SIMONA® thermoplastics are exposed to loads in the form of more or less substantial friction. This can cause static. On account of the relatively high surface resistance the charges flow along the surface very slowly and can trigger spark discharges (explosion hazard). At the same time, static attracts dust, which can make the surface unattractive for certain applications. The solution is to increase the conductivity of the material, either by adding antistatic agents (internal treatment) or by surface modification. Antistatic SIMONA® thermoplastics only undergo internal treatment, which ensures a longterm effect. However, with these antistatic products it should be noted that the above mentioned properties are dependent on atmospheric humidity.

6 Chemical properties

In the chemical industry, plastics are normally used for their chemical resistance to chemically aggressive media. This means that under the influence of certain media the plastics must not change to such an extent that their performance is impaired.

Generally speaking, the intensity of chemical attack increases in proportion to a rise in temperature, rise in concentration and rise in the length of time of exposure.

Plastics are classified as organic materials so they have relatively low bonding forces that can have a negative influence on certain chemicals. Apart from the chemical media being conveyed, changes in the plastics can also be caused by ultraviolet light, heat, oxygen or even a combination of these influencing factors. The result will be premature ageing, and hence a shorter service life.

Owing to the different atomic composition of the various plastic molecules, their levels of chemical resistance also vary. For example, polyolefins (plastics that only consist of carbon and hydrogen, e.g. PE and PP, see Section 3.1 and 3.2) react with oxidising media such as chromic acid, causing material embrittlement or even the occurrence of stress cracks. PE is excellent for alkalis, e.g. sodium hydroxide, at room temperature. PVC-U (plasticiser-free PVC) is highly suitable in contact with oxidising media such as hydrogen peroxide or 96% sulphuric acid. For many solvents, e.g. acetone, PVC-U is normally unsuitable, or only suitable under certain conditions. PVDF is highly suitable for contact with heavily oxidising media, e.g. chromic acid or chlorine. PVDF is not very suitable in the alkaline range, e.g. for sodium hydroxide. In the presence of alkalis PVDF can react within a short space of time and cause stress cracks. The chemical resistance of ECTFE is usually above that of PVDF.

As opposed to PVDF, however, ECTFE exhibits good resistance to alkaline media. Normally the chemical resistance increases in proportion to the fluorine fraction of the plastic molecule.

When selecting a plastic for a certain application it is necessary to know not only the medium being conveyed but also other parameters, e.g.:

- Single chemical or a mixture
- Concentration of the medium
- Application temperature (fluctuations)
- Mechanical load, e.g. pressure, dynamic stress
- Length of exposure (continuous / brief)
- Indoor or outdoor use
- Use in a potentially explosive atmosphere
- Contact with food
- Certain fire rating required
- Other approvals required
- Abrasion
- Diffusion

If a medium damages the plastic, the evidence of damage can vary, e.g.:

- Increase in mass (usually swelling)
- Decrease in mass, or even disintegration
- Discoloration (in the case of fluoroplastics this does not have to involve any damage)
- Embrittlement / formation of stress cracks
- Cross-linking

If no empirical data is available on the behaviour of the plastic in relation to the medium being conveyed, only an estimate can be made at short notice. For a more accurate statement it is necessary to conduct an immersion test, either in the laboratory or in the field.

There are various industrial standards for the purpose of assessing the chemical resistance of thermoplastics, e.g.:

- ISO 4433
- DIN 16888
- DIN EN ISO 175

In accordance with these standards the test specimens are immersed without any exposure to stresses or strains. A statement on a possible effect that triggers stress cracks is therefore either impossible or only possible to a limited extent.

SIMONA® semi-finished products can be tested and assessed in the company's own laboratory in accordance with ISO 4433. As regards the assessment of chemical resistance, the change in mass and mechanical properties (modulus of elasticity, yield stress, elongation at yield and elongation at break) can be used. The chemical resistances are listed in our SIMCHEM database (www.simchem.de).

To be able to assess a possible stress crack-triggering property of a medium being tested, test specimens subjected to voltage are also immersed in the particular medium as part of our exposure tests. A statement about the determination of resistance to environmental stress cracking (ESC) is provided by DIN EN ISO 22088.

In a material immersion test the standards we have just mentioned about the determination of chemical resistance and the determination of environmental stress cracking cannot provide a numerical measurement in order to take into account the influence of the medium on the thermoplastic in mathematical tank design.

To take into consideration the influence of the medium on the design of a thermoplastic tank, a factor called chemical resistance f_{CR} has been introduced.

In tank design the chemical reduction factor A_{21} (reduction in stability and deformation) or A_{2B} (reduction in stress) is taken into account. The A_2 factor represents the reciprocal value of the factor of chemical resistance f_{CR} : $A_2 = 1/f_{CR}$.

This factor indicates the effect of a chemical on the thermoplastic in relation to water. The factor is always ≥ 1 . If the factor is 1, this means that the chemical acts on the thermoplastic like water. It is determined in accordance with DIN 16889.

The published list of chemical resistance of SIMONA® materials normally only shows single chemicals. In practice, mixtures of various chemicals that are not shown on that list are used in the majority of cases. In such cases, please contact our Technical Service Centre for a material recommendation.

7 Other properties

7.1 Physiological safety

7.1.1 Contact with food according to European Directives

In Europe there are strict legal regulations for materials that are intended to come into contact with food. For all materials used in food contact (not only plastics) a so-called Framework Regulation has to be complied with. At present, the applicable provisions are set out in EC Regulation No. 1935/2004 passed by the European Parliament and the Council of the EU on 27 October 2004.

With regard to all materials that come into contact with food it is a basic requirement that no substances should pass from them to the food. If this happens nevertheless, Article 3 of EU Regulation 1935/2004 specifies the quantity of migrating constituents as follows:

- There must be no risk to human health
- There must be no unacceptable change in the composition of the food
- There must be no detrimental effect on the taste or smell properties of the food

EU Regulation 10/2011 (previously 2002/72/EC) includes a so-called positive list indicating all the approved materials/additives. This new EU Regulation 10/2011 has been in force since 1 May 2011; it is an integral part of EU Regulation 1935/2004.

The European Food Safety Authority (EFSA) is the institution for evaluating applications for the inclusion of new substances in the positive list of EU Regulation 10/2011. In particular, there is a health assessment of substances that pass from materials to food.

The general rule is: the more of a substance passes into food, the larger the volume of data that has to be presented for an evaluation, and food approval becomes all the more difficult.

The most important aspects of EU Regulation 10/2011 are:

- A positive list of starting materials (monomers) and a substance list of correctives (additives) that may be used to manufacture plastics
- Migration procedure based on limits and purity specifications
- Manufacture according to EU 2023/2006 (GMP = Good Manufacturing Practice)
- Batch tracking and the resulting declaration of conformity confirming the above-mentioned requirements

The materials manufactured by SIMONA according to the above criteria, tested by independent institutes for migration and listed below are fundamentally suitable for contact with food:

- PE-HD (natural, black)
- PE 100 (natural, black)
- PE 500 (natural, black, green, dark blue, light blue, red, yellow, reddish brown, grey)
- PE 1000 (natural, black, green, dark blue)
- PP-H natural, PP-H AlphaPlus®
- PP white 9002
- PVDF
- PVC-LZ
- SIMOPOR-LZ

Tests conducted on SIMONA® ECTFE at the Fresenius Institute in Taunusstein demonstrated that ECTFE meets the recommendations issued by the Plastics Commission of ‚BgVV‘ (Federal Institute for Consumer Health Protection). However, no application has yet been filed for BgVV or FDA approval.

On the other hand, electrically conductive materials and materials that are adjusted for low flammability by means of halogen-containing flame retardants are not approved for contact with food.

Further information regarding food approvals can be found on the website of BfR (Federal Institute for Risk Assessment) at www.bfr.bund.de and on the website of EFSA (European Food Safety Authority) at www.efsa.europa.eu/de.

7.1.2 Contact with drinking water

The European Drinking Water Directive constitutes the highest international standard. The Drinking Water Directive of the European Union (EU Directive 98/83/EC) specifies that drinking water for human use must be free of pathogens and germs and be flawless with regard to taste, smell and appearance („pure and clear“).

The quality of drinking water in Germany is regulated by the Drinking Water Regulation TrinkwV 2001 (with amendments from 2012). It contains all the requirements for short- or long-term installations. It constitutes the implementation of EC Directive 98/83 (CELEX No. 398L0083) in national law.

For the hygienic assessment of organic materials in contact with drinking water the

German Environment Agency („UBA“) issues guidelines in the form of various recommendations.

The guidelines issued by the German Environment Agency concerning hygienic assessment of organic materials in contact with drinking water were published initially as drinking-water contact recommendations („KTW“) in 1977. In the meantime the drinking-water contact recommendations have been superseded by various new guidelines issued by the UBA. The tests can be subdivided into a test conforming to KTW recommendation / KTW test guideline and a test conforming to DVGW (German Gas and Water Association) Worksheet W 270.

The KTW test is a test conducted on the end product. The standardised procedure, subdivided into three intervals, is performed on the product itself after practice-oriented pretreatment (including pre-soaking and rinsing). The total time required for the test procedure is 10 days. Essentially, the following parameters are tested:

- external quality (incl. clarity, colour, odour, taste),
- emission of organically bound carbons (TOC) and
- chlorine depletion.

The test conforming to DVGW Worksheet W 270 is purely a material test. The item to be tested is immersed in a basin subject to a continuous flow of test water over the entire duration of testing. The total time required for the test is 6 months. After 3 and 6 months the test specimen is removed and examined for its microbiological longterm behaviour (incl. formation of growth).

We have performed a KTW test and a DVGW-W270 test for the following SIMONA® materials:

- PE 100
- PP-H AlphaPlus®
- PP-C light grey
- PVC-DS-TW
- SIMOLUX

Since the radiation dose lethal to human beings is approx. 0.0006 Mrad, all known plastics can naturally be used wherever people can also be located without endangering themselves.

Further information can be found on the website of the German Environment Agency at www.umweltbundesamt.de, in particular the guideline at www.umweltbundesamt.de/sites/default/files/medien/374/dokumente/ktw_leitlinie_070316.pdf and on the website of DVGW (German Gas and Water Association) at www.dvgw.de/465.html.

7.2 Radiation resistance

The effect of high-energy radiation on plastics does not depend on the type of radiation but solely on the amount of radiation dose (exception: in the case of very heavy particles such as α particles, protons, etc.). On account of irradiation in the ambient atmosphere the creep rupture strengths are much shorter than with the exclusion of atmospheric oxygen. The dose levels crucial for creep rupture strength can be seen by referring to Table 9.

Material	Maximum permissible dose Mrad *	Long-term exposure dose Mrad *
PE-HD	10	1
PP	3	0.1
PVC	60	6
PVDF	40	20
E - CTFE	200	50

* $10^4 \text{ J/kg} = 1 \text{ Mrad}$

Table 9: Radiation resistance

8 Long-term properties

8.1 Test methods

If you compare the mechanical properties of different thermoplastics, the comparisons relate to short-term properties (e.g. toughness, strength). However, thermoplastics tend to creep when subjected to a mechanical load. Their mechanical properties are therefore time-dependent.

For this reason, when a component is being designed the creep properties are taken into account by inserting specifications obtained from creep tests. The parameters involved are the so-called **creep modulus** and creep strength. Safety factors also take into account the **long-term welding factor**.

Various methods of measurement are available for the purpose of measuring long-term properties.

8.1.1 Tensile creep test

In a tensile creep test a test specimen with defined dimensions is subjected to continuous strain. It is important to ensure that the conditions such as temperature, force and medium are kept constant.

The time to failure under a defined load is recorded as a parameter. Different loads then lead to a group of curves that characterise the material with regard to its load. If you compare welded and unwelded test specimens, the quotient is the long-term welding factor. To minimise testing times, stress crack-promoting media are also used instead of water. Notch-sensitive materials such as PE 63 and PE 80 react very sensitively to such media.

A tensile creep test is also used to measure creep modulus. As time increases, the slope of the stress-strain curve changes towards lower values. The creep moduli of different thermoplastics can be seen by referring to guideline DVS 2205-1.

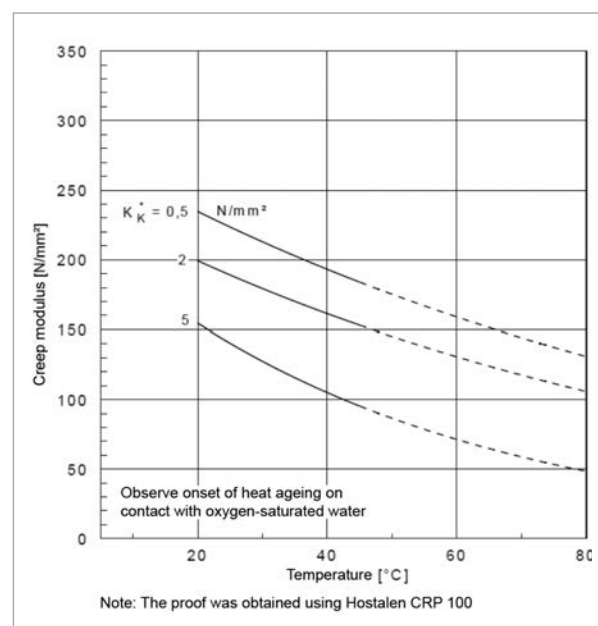

Figure 48: Creep modulus of PE 100 for 25 years

8.1.2 Internal pressure creep rupture strength test

To characterise pipes, the internal pressure creep rupture strength test is used. For this purpose, pipes or parts of pipelines are filled with water at internal pressure. By varying the pressure and temperature, you obtain a group of curves, from which the pressure-specific load-bearing capacity of a material can be determined (see DVS 2205-1). This test also provides the names for PE types. PE 100, for example, means that after exposure to water at 20°C for 50 years the minimum material strength can be expected to be 10 MPa.

If you compare welded pipelines with unwelded ones of the same type, it is possible to check the long-term strength of the connection system and determine the long-term welding factor.

8.1.3 Full notch creep test (FNCT)

The failure of test specimens or components is always due to more or less severe defects or inhomogeneities in the material. In the case of very homogeneous materials, such as thermoplastics, these defects are minimal. Therefore, the testing times are usually longer. A creep test at temperatures up to 40 °C usually takes up to 10,000 hours. This roughly corresponds to an operating time of more than a year in 24h duty.

Investigations have shown that characterisation of the material can also be performed by means of fracture mechanics. A notched test specimen is used, which then fails under strain much more quickly than an unnotched test specimen. The FNCT uses a rectangular test specimen with a sharp perimeter notch, which is subjected to strain in a surfactant solution. To further reduce the testing time, with PE materials the test takes place at 80 °C under a load of 4 MPa. The minimum requirement (according to DVS 2205-1, BB1) for creep rupture strength is, for example, 100 hours for PE 80, 300 hours for PE 100 and as much as 8,760 hours for PE 100 RC.

You will find further information about the FNCT test in DVS 2203-4 Supplement 2.

In future, more test variants are to be included in DVS, depending on the thickness of the test specimen. They include, for example, the 2-notch creep test (2NCT) (DVS 2203-4 Supplement 4).

8.1.4 Creep curves

Creep curves are fracture curves, the position of which is largely dependent not only on the material but also on mechanical load and temperature.

Creep tests are generally conducted using five test specimens, which are exposed to constant load and temperature. The time to failure of the test specimen (break) is recorded as the creep rupture strength; the mean is calculated from all the creep rupture strengths determined and plotted on a (double-logarithmic) creep diagram. This procedure is conducted for different loads, always at the same temperature. Later, with a cumulative frequency of 97.5% these averaged creep rupture strengths generate the minimum creep rupture strengths and then, by means of linear regression, the minimum creep curve.

Many creep curves are shown as broken lines for creep rupture strengths of $>10^4$ h because for those times no test results are available. By contrast, there is over 25 years of experience in creep rupture strength in the case of PE-HD, PP-H, PVC-U and PVDF. Creep curves for pipes made of the said standard materials are printed in DVS 2205-1. The broken line used to be generated by extrapolation/interpolation (for certain temperatures) according to the Arrhenius law. The procedure assumes that by means of experiments at high temperatures it is possible to deduce behaviour at low temperatures. For most materials nowadays there are only continuous lines.

Material ageing, which has an effect due to embrittlement, restricts the possibility of extrapolating creep curves. One criterion to be applied for ageing is, for example, the decrease in tensile strain at break by a certain percentage. Since no material-specific limits have

been defined yet, there is no age limit line on the creep diagrams. A PE 100 creep curve can be seen below.

How are creep curves used?

With the aid of a creep curve (see Figure 49) it is always possible to determine the amount of load for a specified service life t_1 and service temperature T of a component (fracture curve for water: $K = 5 \text{ N/mm}^2$).

However, the stress values determined do not take into account the actual loads in practice, brought about by more or less aggressive media and welding processes. These have to be determined separately (see also DVS 2205-1, DIBt media list). Those service conditions are reflected by an imaginary curve (see Figure 50). In the example shown the stress value is $\sigma_A = 3 \text{ N/mm}^2$.

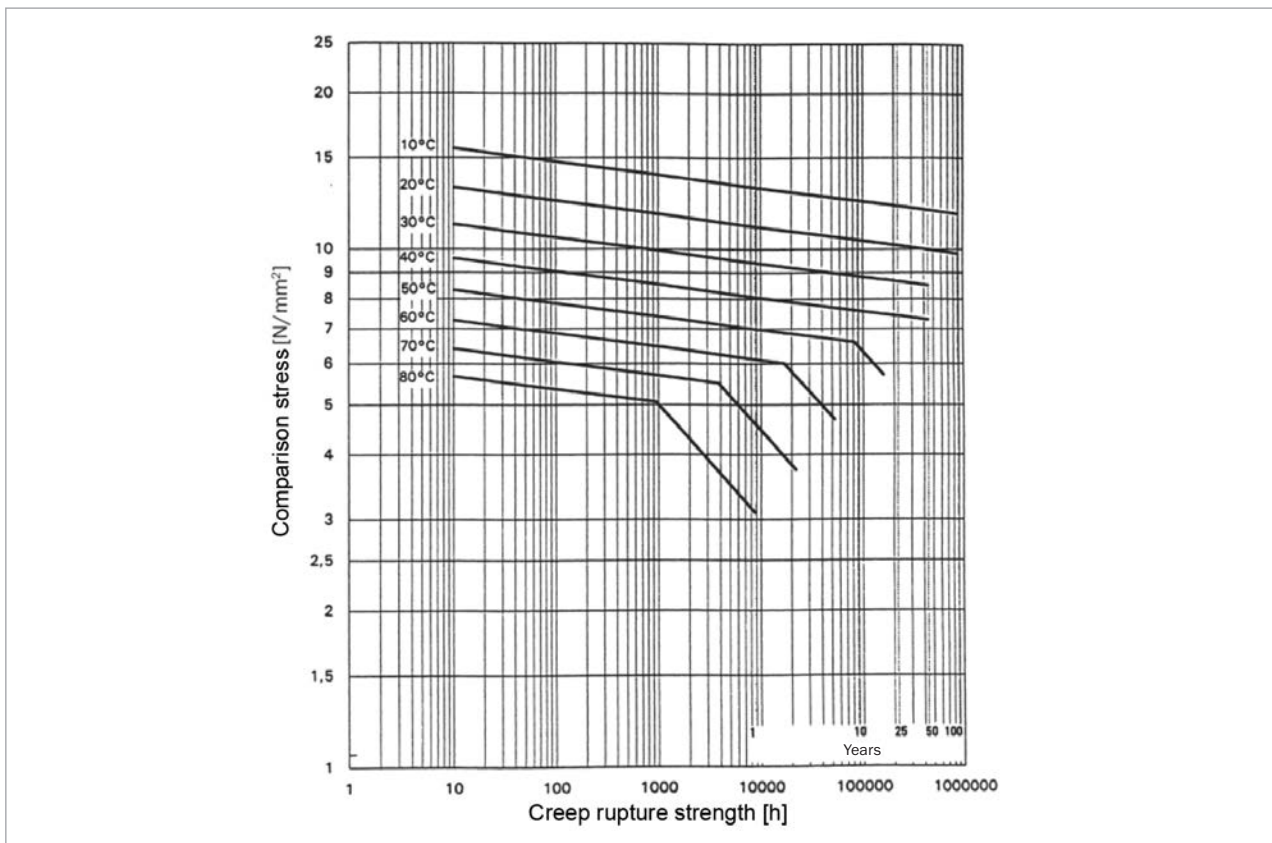

Figure 49: PE 100 creep curve

It is also possible to use a creep diagram to determine the actual service life t_2 of a component. Here in the example the maximum service load is $\sigma_{perm} = 1.5 \text{ N/mm}^2$.

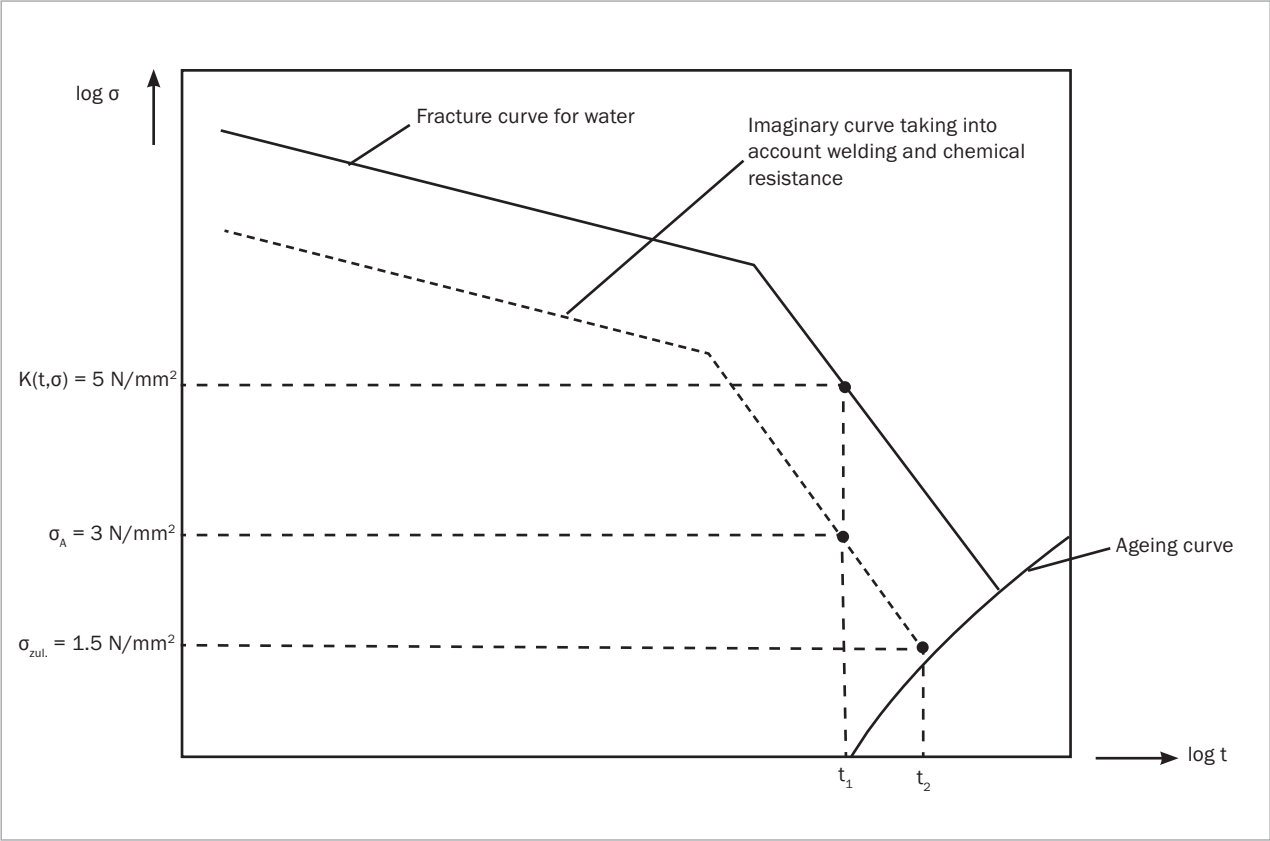

Figure 50: Using a creep curve

8.1.5 Isochronous stress-strain diagrams

Isochronous stress-strain diagrams are some of the most informative diagrams. They can be used to determine time-dependent stress and deformation changes (on the lines of the same useful life = isochronous) for retardation and relaxation cases. The creep modulus is also easy to calculate as a function of time and stress. For components that are exposed to a constant load, the intersection with isochronous lines (time, dependence on temperature; see example of PE 100 curves) and stress indicates the time-dependent strain values. However, only the permissible strain values should be taken into consideration.

In a relaxation case, i.e. where deformation is constant, the stresses in the material decrease on a time-dependent basis.

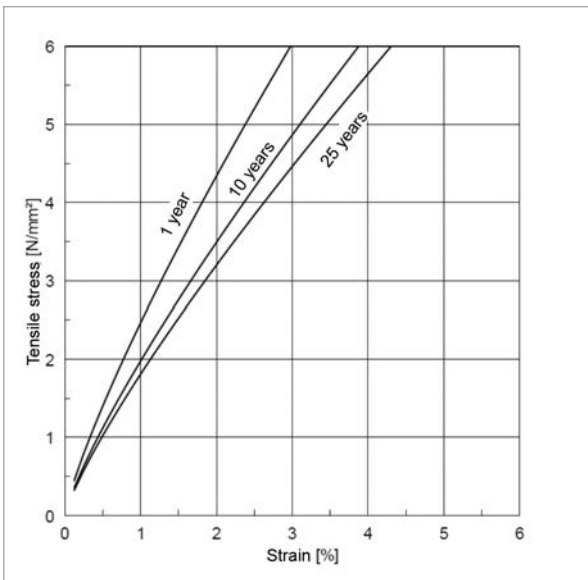

Figure 51: Isochronous stress-strain diagram of PE 100 for 23 °C

What does this mean for practical situations?

Since thermoplastics in long-term use not only reduce stresses but also tend towards more or less substantial creep, isochronous stress-strain diagrams can be used to forecast, inter alia, behaviours at the beginning of use of a material.

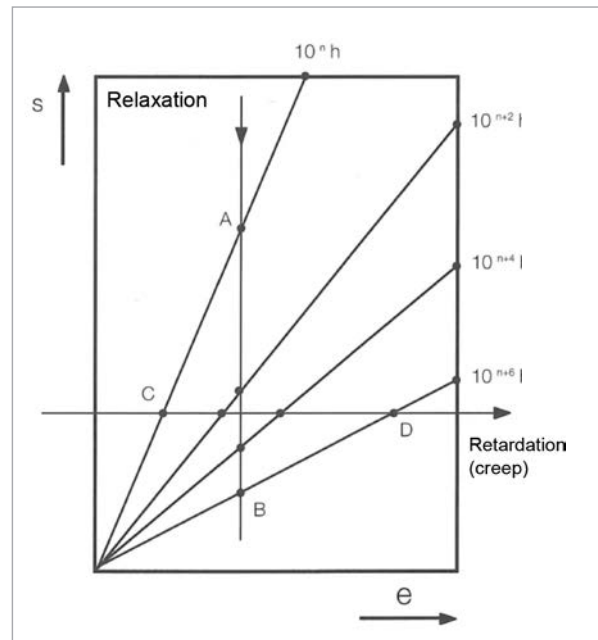

Figure 52: Relaxation and retardation sections on an isochronous stress-strain diagram

On the vertical straight line of relaxation it is possible to read off how long it will take to reduce a certain amount of stress that was introduced to the material by external loads. Point A on the diagram shows at 10^n hours a certain stress value in the material which has been considerably reduced at point B after 10^{n+6} hours.

On the other hand, it is possible to use the horizontal straight line of retardation at a constant external load being applied in order to determine by what amount a

thermoplastic expands (creeps) for various usage times. At point C the material at 10^n hours has less strain than at point D for longer usage times (10^{n+6} hours).

8.2 Structural analyses

Our technical service departments (the Technical Service Centre and the Applications Technology Department of the Pipes and Fittings Division) will be pleased to conduct, on request, structural analyses for tanks in accordance with the guidelines issued by the German Welding Society and Related Processes („DVS“) 2205-1, 2 and 5 as well as appropriate structural proofs for pipes in accordance with the guidelines issued by the German Wastewater Association ATV A 127, ATV M 127 and DVS 2210. These structural analyses for thermoplastic components are recognised by independent testing bodies as verifiable.

When designing components and tanks made of thermoplastics, their time- and temperature-dependent property profile plays a key role. Calculations are always based on long-term data. Generally speaking, three criteria have to be taken into account, depending on the type of load:

1. Maximum permissible stress:

Calculation is performed with reference to the creep strength $K(t, T)$ of the material being used (see supplements to DVS 2205-1). The latter indicate the long-term strength of thermoplastics as a function of time t and temperature T under the action of water as a medium. The creep values found are used to determine the maximum permissible stress of a component in relation to the chemical influences of the media.

2. Deformation (e.g. elongation):

The characteristic value is the so-called creep modulus E_c . This is the quotient of stress and total strain. The creep modulus is time- and temperature-dependent and can be determined by means of so-called creep curve diagrams (see supplements to DVS 2205-1).

3. Rigidity

In the case of components with very large surfaces the rigidity of the plastics used is the crucial factor for determining the wall thicknesses required. If deflection of a tank wall is too large with the wall thicknesses calculated according to 1. or 2., a large part of the external load must be absorbed by membrane forces, i.e. tensile forces. In such cases it is necessary to increase the wall thickness. This leads to an increase in sheet rigidity and minimisation of stresses occurring.

Also when designing pipes a stability proof is conducted in order to determine the safety margin between the critical load and the load actually existing. This is done taking into account the influences of total vertical load (soil load and live load), external water pressure (groundwater) and superposition of total vertical load and external water pressure.

To make it easier for our Applications Technology Department to render this special service, we are pleased to make questionnaires available to you about the structural design of tanks, shafts and pipelines, for downloading from our website (www.simona.de/download). Our staff look forward to answering your questions in advance about potential applications of the various SIMONA® plastics.

8.3 Materials in tank construction requiring mandatory test certificates

According to Sections 62 and 63 (since 2010) of the German Water Management Act (,WHG'), installations and installation sections for storing, filling or transferring soil- and water-endangering liquids are subject to certain manufacturing and monitoring rules. These are laid down, among other things, in the Construction and Testing Policies (,BPG') issued by Deutsches Institut für Bautechnik (,DIBt' – Centre for Competence for Construction) in Berlin. According to BPG, especially installations and tanks made of thermoplastics may only be made from semi-finished products whose raw materials have been approved by DIBt.

In compliance with the Construction and Testing Policies, SIMONA® semi-finished products are subject to strict criteria of material selection and processing. Only continuously monitored base materials enter the processing sequence, which is also subject to continuous monitoring. Monitoring is based on DIN EN ISO 9001. In addition, SIMONA® products are subject to external monitoring by the South German Plastics Centre (,SKZ') in Würzburg, the Technical Inspection Association ,TÜV Süd' and the German Plastic Pipes Association ,KRV' (called ,GKR Bonn' up to 2003). This ensures that the products manufactured by SIMONA AG are of the accustomed high quality.

9 Plastic physics

9.1 Stress types

All semi-finished plastic products and all components manufactured from them have a high inherent stress potential that is not due to the action of external forces. It concerns internal stresses that are brought about by the manufacturing process.

Plastic melt plasticised in the extruder is extruded into the roll gap of the calender stack through a gap in the flat-sheet die. When the melt has already cooled down slightly, it is cooled below melt temperature so that the shape provided by the mould remains intact. Cooling the extrudate from outside generates a temperature gradient between the outer layer and the interior of the semi-finished product. The inner layer of the semi-finished product is now also cooled down slowly and the heat is emitted to the outside. Owing to the outer lining, which has already solidified, the volume is kept constant. However, the inner layer attempts to shrink on account of the high thermal strain, which is hindered by the rigid outer layer. As a result of this process internal stresses remain in the semi-finished product (**cooling stresses**), which can be observed during processing. A sheet with high inherent stresses bends, for example, when it is heated. In the case of thick-walled pipes it is also possible to detect the amount of inherent stresses from the fact that the pipe ends have a smaller radius than the middle of the pipe. Another reason for internal stresses is the stretching of the molecules during extrusion (**orientation stresses**). However, compared to cooling stresses this fraction is normally low.

Generally speaking, **inherent compressive stresses** mainly occur wherever the cooling rate is relatively high. **Inherent tensile stresses** mainly occur wherever the cooling rate is relatively low.

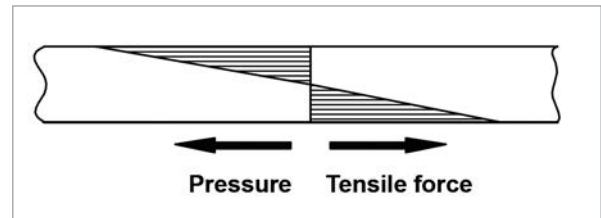

Figure 53: Stress orientations

In injection moulding **inherent after-pressure stresses** also occur which can arise due to excessive pressure on the moulding during the cooling process. This can often be avoided by providing appropriate vents. If excessive inherent stresses occur in an injection-moulded part, it becomes apparent either from excessive shrinkage or from a change in shape during exposure to heat.

When partially crystalline thermoplastics cool down (cooling from the melt to the thermoplastic range) the material crystallises out. This results in volume contraction. If cooling is not uniform, a later crystallisation process takes place with strain on the assembly parts (**inherent crystallisation stresses**).

Inherent embedding stresses that are relatively high are only found in the microscopic (very small) range of the material or in the sub-microscopic range, i.e. in the range of atoms and molecules.

- **Inherent stresses in the microscopic range** = stresses in the vicinity of filler particles or colour pigments
- **Inherent stresses in the sub-microscopic range** = stresses at the boundaries of the crystalline zones with spherulite formation (this type of inherent stresses is important for the material polypropylene, for example)

Of all the types listed so far, special importance must be attached to inherent cooling stresses. The amount of inherent stress potential arising in forming or reforming increases

- if the cooling rate rises;
- if the difference in specific volume (or density) that occurs during the process rises.

Figure 54 shows a diagram of the specific volume in relation to temperature for amorphous and partially crystalline thermoplastics.

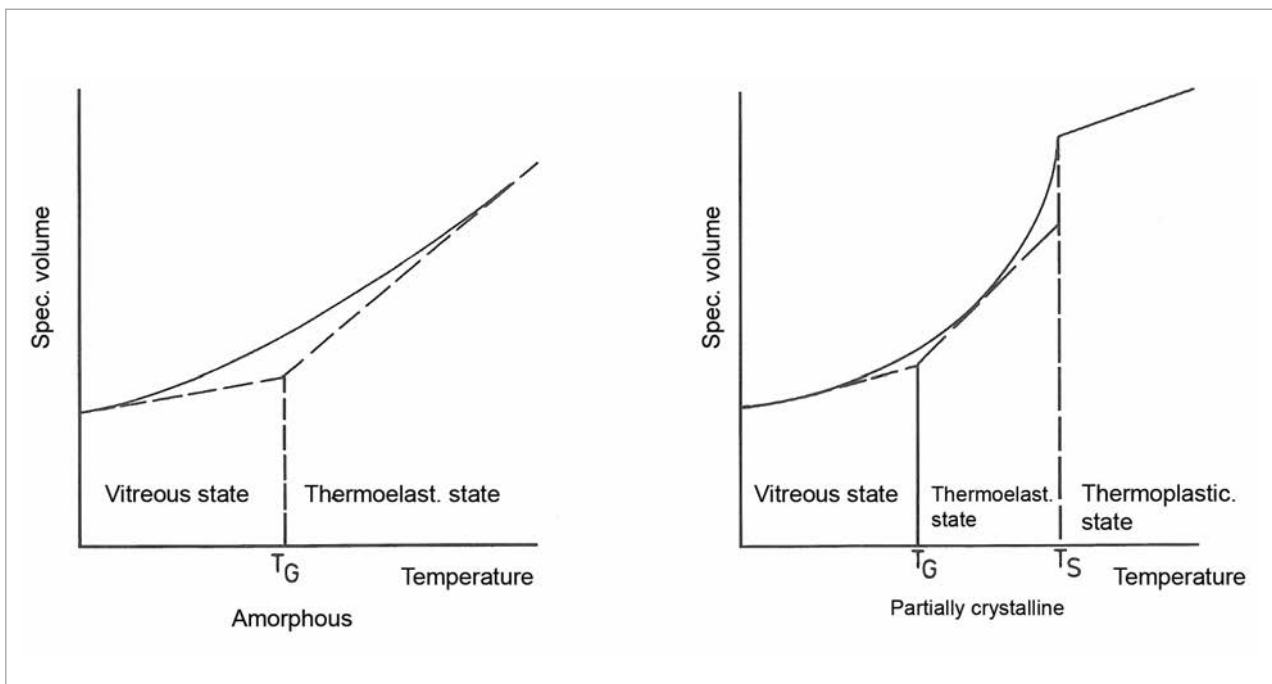

Figure 54: Dependence of specific volume on temperature; left: amorphous thermoplastics; right: partially crystalline thermoplastics

9.2 Reduction of inherent stresses

Partially crystalline thermoplastics in particular have widely varying specific volumes between melting point and room temperature. To minimise the resulting level of inherent stresses, forming temperature should be just above the crystalline melting range. In many cases the forming and reforming processes do not allow systematic influencing of the parameters that generate inherent stresses. One remedy in this context is the option of subsequent heat treatment by annealing. To achieve maximum success with this process a number of influencing variables should be taken into account because the heat treatment temperature has to be selected according to the material.

- Amorphous material: Annealing close to glass transition temperature
- Partially crystalline material: Annealing approx. 10 to 20 K below the crystalline melting temperature

In the case of materials with a high orientation state the heat treatment temperature used must be lower. At high temperatures, restoring forces may occur, which can lead to slight deformations. The duration of annealing is determined by the thickness of the body being annealed and the position of the stress profile in the wall cross-section.

Heat treatment should be split up into a warming phase, a holding phase and a cooling phase. Warming can take place relatively quickly if compressive stresses exist at the surface. In this case a heating rate of 20 K/(min-wall thickness in mm) is sufficient. Holding time depends on the thickness of the semi-finished product and the pressure of the ambient air. At normal atmospheric pressure the time of the maximum temperature should be about

20 min/mm. That is followed by cooling, which should be performed very carefully and slowly. A cooling rate of 5 K/(min-wall thickness in mm) is to be recommended. However, when cooling, it is not always necessary to cool down to room temperature. The semi-finished product can usually be removed from the oven at a temperature of 40°C.

Generally speaking: the higher the temperature, the lower the rate of cooling should be.

Annealing plastic parts is generally only useful if a change in shape due to thermal expansion can take place without any hindrance. If this is not the case (e.g. plastic sheet firmly clamped in a metal frame), heat stresses are bound to develop there. The time for the annealing process must therefore be selected carefully within a production sequence.

Solid rods made of thermoplastic polymers are usually prone to a high inherent stress potential. During machining it is advisable to only produce blanks first because deformations induced by inherent stresses occur and continue to change after the annealing process.

If the blank is in a virtually stress-free state, production takes place according to final dimensions by means of properly executed operations (in order to avoid further deformations). The low-stress state of the component allows relatively narrow production tolerances.

When annealing pipes it must be possible to supply and dissipate the heat internally and externally. Since pipes made of PP homopolymer in particular are prone to a high potential of inherent stresses, all SIMONA® PP pipes are annealed with low stress in an inline process. On

account of this heat treatment the load capacity can be increased considerably.

In thermoforming as well, cooling stresses can be frozen, which then influence processing contraction and post-contraction. In this context, high tool temperatures and low cooling rates are an advantage.

9.3 Heat stresses

If thermal expansion (dilatation) of a body is hindered by external constraints, heat stresses develop.

The amount of heat stresses in a particular case can easily be estimated with the following equation:

$$\sigma_w = \pm E \cdot \alpha \cdot \Delta T$$

σ_w = heat stress

E = modulus of elasticity

α = mean coefficient of thermal expansion

ΔT = temperature difference

The equation shows that stress and temperature difference are proportional to one another. However, practice has shown that, for example, the compressive heat stresses arising when a body is heated up are lower than the ones roughly calculated beforehand. Here the deviations between actual and calculated heat stress tend to increase as temperature rises. The reason for this is the dependence of the modulus of elasticity and the coefficient of linear expansion on temperature. Whilst the modulus of elasticity declines as temperature rises, the coefficient of linear expansion increases. However, since these opposite tendencies do not generally compensate each other, the product of the modulus of elasticity

and coefficient of expansion cannot be regarded as a constant. In addition, the above estimation does not take relaxation processes into account. If the temperature rise takes place slowly though, any heat stresses occurring can be partially reduced by relaxation.

This effect of stress relaxation in particular can always change the stress balance of a component if there are multiple alternating temperature cycles. Since stress relaxation takes place very quickly beyond glass transition temperature (amorphous thermoplastics) or the crystalline melting range (partially crystalline thermoplastics), the above equation only applies below that temperature limit.

To illustrate, the heat stress characteristic is plotted as a function of time for a test specimen clamped in the tensile testing machine for multiple alternating temperature cycles (Figure 55). For simplification purposes the temperature changes should take place in surges (not technically feasible in general).

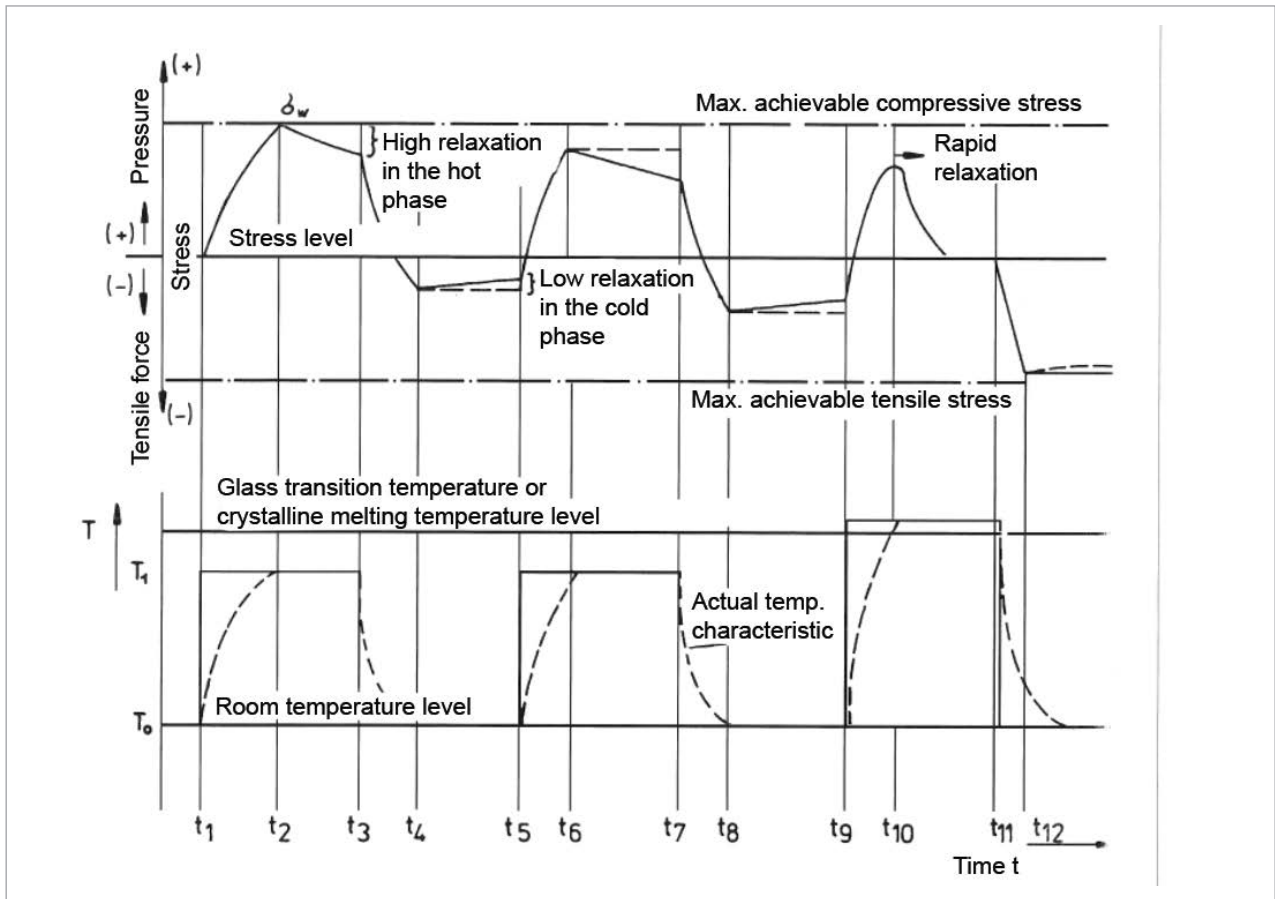

Figure 55: Stress characteristic for alternating temperatures

If the test specimen firmly clamped into the tensile testing machine is exposed to a temperature, a compressive stress σ_w develops with a certain delay (plastic is a poor heat conductor). At time t_1 the entire cross-section of the test piece is at temperature level T_1 . If the change in temperature is consistent, relaxation processes occur at t_2 , i.e. the stress decreases degressively in the course of time. At time t_3 the original temperature level T_0 is restored. The stress change $\Delta\sigma$ between times t_2 and t_3 is virtually identical to the one during the heating operation. Owing to the relaxation process in the warm phase

at time t_4 a stress level is reached which is below the starting level.

The test specimen now has inherent tensile stresses after the first alternating temperature cycle. In time interval t_4 to t_5 the temperature continues to be kept constant. Stress relaxation also takes place in the cold range, although it is much lower. The relaxation rate must be regarded as being dependent on temperature. This explains the higher tensile stress potential after the second alternating temperature cycle.

In terms of tendency it is already evident that after further alternating temperature cycles there is a continuous shift in heat stress from the compressive stress range to the tensile stress range. The maximum tensile stress that can be achieved in doing so is also σ_w .

After an infinite number of cycles the heat stress will now always be somewhere between the zero stress level and σ_w . This means that when the maximum temperature is reached in the service cycle there will never be any tensile stresses, i.e. the zero stress level will prevail.

In the case of alternating temperature cycles whose maximum temperature T_1 is below the glass transition temperature of a material, it will be necessary to apply a large number of cycles or one cycle with a sustained high temperature in order to completely shift the stress curve into the tensile stress range. The situation is different when heating a material above the glass transition temperature. Here the compressive stresses are reduced so quickly above this zero level that a balanced stress level is reached after only a short time. If a cooling process now takes place, the tensile stress that develops will be very high. The higher it is, the higher the temperature that developed during the warm phase ($\sigma_w = f(\Delta T)$). The process just described is illustrated in Figure 55, in time interval t_9 to t_{12} .

Heat stresses in practice

If, for example, in the case of internal tank lining or a composite tank (GRP-thermoplastic) gaping cracks become visible in the lining as result of damage, this is clearly an indicator of failure due to excessive heat stresses.

In practice, knowledge of such processes can make a substantial contribution to identifying the root cause of any incidents where damage has occurred.

Here is a typical example of an incident where excessive heat stresses led to failure of the material:

- a damaged component shows gaping cracks
- the component was exposed to one or more alternating temperature cycles
- the component was hindered in executing thermal expansion at right angles to crack propagation

Owing to the resulting heat stresses, any attempt to eliminate inherent stresses that prevail between two fixed points of a part by annealing is futile because, on the contrary, the damaging tensile stresses induced by heat stresses increase further (this can also apply to composite components).

Orientations

Inherent stresses arise due to energy-elastic deformation, i.e. interatomic distances and valence angle change due to the introduction of thermal energy, for example. In the process there is a change in inner energy, and consequently in volume as well. As opposed to this, the volume remains constant during orientation. This orientation of molecules is caused either by:

- **thrust forces**, like those that occur when melts flow in channels (extrusion), between plastic walls that have already solidified (injection moulding) or between rolls (calendering)
- **expansion forces**, like those that occur, for example, in a tensile test, in blown film extrusion, in the inlet zone of extrusion dies or at cross-section constrictions

If such plastic melts oriented by thrust or expansion forces cool down beyond the crystalline melt range or the glass transition temperature, those orientations are frozen and molecular deformation remains intact below the glass transition temperature. Only above that glass transition temperature do the molecules restore their statistically random coil shape, unless forces ensure maintenance of deformation. If an oriented test specimen is clamped into a force measuring device (e.g. a tensile testing machine) and heated above the glass transition temperature, (tensile) forces occur which are higher the more the rod is oriented. For this reason the term often used is „frozen stresses“ in connection with orientation.

In this area, there is often confusion with the term „inherent stresses“ (see Section 9.1 Stress types), which arise when melts cool down. Orientations and inherent stresses are, however, fundamentally different in terms of origin and effects.

This difference can be illustrated by taking a thick-walled thermoformed part as an example. Thick-walled sheets have an approximately parabolic inherent cooling stress characteristic with compressive stresses on the outsides and tensile stresses at the centre. On request, SIMONA produces sheets that are specially suitable for thermoforming. Such sheets have a high orientation level. The reason for this is as follows:

In thermoforming the cold sheet is firmly clamped into a metal frame. The thermal expansion caused by heating is hindered in an axial direction, due to the fixed clamping. For this reason the sheet begins to canoe. On exceeding the glass transition temperature (amorphous thermoplastics) or the crystalline melt temperature (par-

tially crystalline thermoplastics) entropy-elastic restoring forces begin to act. The macro-molecules endeavour to assume the state of maximum entropy and hence „randomness/coil shape“. The stretched, oriented macro-molecules contract again. Canoeing stops and the sheet becomes tense. Only if the temperature continues to rise do the viscous properties of the melt take effect and supporting air is required to keep the sheet almost flat.

In thermoforming proper that now follows the material is stretched again to a more or less substantial extent. The thermoformed part has a larger surface and generally a smaller wall thickness than the original sheet. Orientation takes place again.

When actual forming has been completed, the thermoformed part is cooled down as quickly as possible for economic reasons. Now the orientations introduced during stretching freeze on account of expansion forces. Consequently, the thermoformed part may possibly have a higher degree of orientation than the original sheet. Owing to the rapid cooling, which generally takes place unilaterally for process engineering reasons (mould cooling is rare in thermoforming), inherent cooling stresses are introduced to the thermoformed part in addition. In the mould, inherent tensile stresses occur during the cooling process because here the cooling rate is lower than on the opposite side facing the cooler. This will exhibit inherent compressive stresses later. Stress distribution in the thermoformed part is consequently linear, as opposed to the parabolic inherent stress profile of the original sheet.

As in the thermoforming process, both the inherent stress state and the orientation state can change in any other forming process (e.g. fold welding, hot bending etc.).

9.4 Influence of orientations on the properties of plastics

Orientations in extruded semi-finished plastics usually have a preferred direction. For example, the degree of orientation in extruded sheets is higher in the direction of extrusion than at right angles to it. Pressed sheets, on the other hand, only have very small orientations because no melt flowing processes occur during the pressing operation. The behaviour of pressed sheets is therefore virtually isotropic, i.e. they have the same properties in all directions. Oriented semi-finished plastics, on the other hand, are anisotropic, so the physical properties are dependent on direction.

The mechanical properties are generally higher in the direction of orientation than at right angles to it. With regard to thermal expansion the same case occurs.

Strength σ_B : $\sigma_{B\parallel} > \sigma_{B,\text{isotropic}} > \sigma_{B\perp}$
Impact strength (in relation to the direction of sampling) a_n : $a_{n\parallel} > a_{n,\text{isotropic}} > a_{n\perp}$
Heat stress α : $\alpha_{\parallel} > \alpha_{\text{isotropic}} > \alpha_{\perp}$

Where \parallel = parallel to the direction of orientation (direction of extrusion) and \perp = at right angles to the direction of orientation (at right angles to the direction of extrusion).

The increase in mechanical strength in the direction of orientation can be explained by the fact that with external loads it is mainly the primary valence bonds that have to absorb the external forces whilst if the load is applied at right angles they are absorbed by the intermolecular bonds or secondary valence bonds.

Since entropy elasticity only commences at temperatures above the glass transition temperature or crystalline melt temperature, it is not possible to eliminate orientations by conventional annealing. The entropy-elastic restoring forces only take effect beyond those temperature limits.

9.5 Shrinkage

Another common name for shrinkage is the „memory effect“, which is particularly evident in the extrusion process. In extrusion the extrudate increases its circumference and becomes slightly shorter.

The molecules originally coiled and looped in the melt at rest are oriented and stretched in the extruder due to a shear load. After leaving the extrusion die they attempt to cancel this forced orientation, i.e. they want to resume their original form (memory effect).

Owing to rapid cooling of the plastic melt, the molecules are hindered from resuming their coiled state and a larger fraction of the orientation remains intact, i.e. it is „frozen“.

On heating up to or beyond the „glass transition temperature“ the above memory effect is resumed.

9.6 Contraction

As with any material the volume of the plastics becomes larger as temperature rises, especially on transition to the molten state. Vice versa, the volume diminishes on cooling down. Since this phenomenon occurs in all processing sequences, volume contraction, especially in the manufacture of plastic fittings, must be taken into

account if a high level of dimensional accuracy is to be achieved.

When taking the contraction dimensions into consideration, a distinction is drawn between processing contraction and post-contraction. Processing contraction is the difference between the dimension of a cold thermoforming tool and that of the cooled thermoformed part after 16 hours of exposure to standard atmospheric conditions of processing (as per DIN 16742). In practice, however, measurement usually takes place after 24 hours. After that, post-contraction begins, which can last for hours or even days. This process is the difference between the dimension of the cold pressed part and the dimension of the same pressed part that is subjected to exposure to heat.

9.7 Influences on component strength

9.7.1 Notch effect

When calculating component stresses, the assumption is usually a uniform (tensile) or linear (bending) stress characteristic over the entire cross-section (Figure 56).

However, in a component subject to a real load such uniform distributions do not exist.

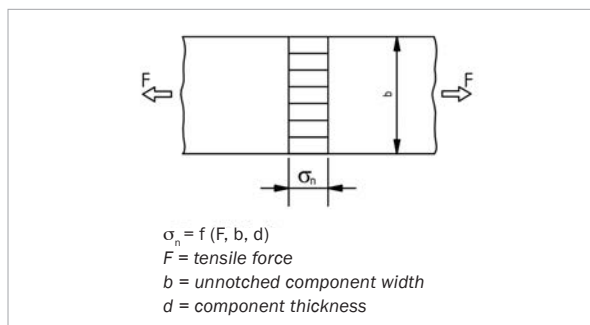

Figure 56: Theoretical analysis of uniform stress distribution

Inhomogeneities in the material, fillers, scratches in the surface, notches and edges have quite a substantial influence on stress distribution. At the edges of such inner and outer notches a stress peak develops on account of the geometric inhomogeneity (Figure 57).

This stress increase is always higher than the mathematical (effective or nominal) stress if stress distribution is assumed to be linear. The stress peak is influenced by the size of the notch, the radius of curvature at the root of the notch and the type of load.

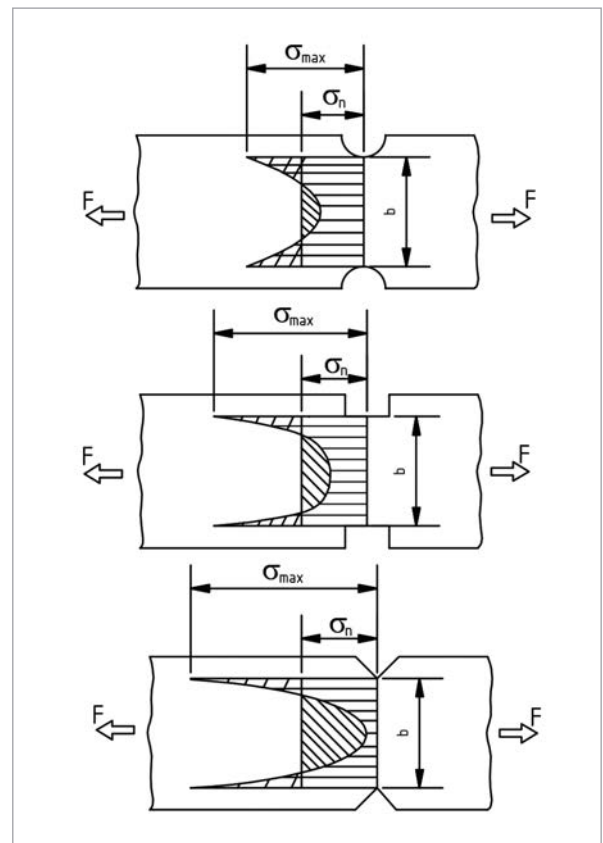

Figure 57: Stress distribution in notched test specimens

As is evident from Figure 57, the notch effect can be kept small by ensuring that transitions are as continuous as possible. The deeper and sharper the notch made, the higher the stress peak at the root of the notch.

Consequently, the strength of a material is not solely responsible for the behaviour of the component under service load – so too are structural shape and surface quality. Since the external shape and internal homogeneity of the material exert a considerable influence on component strength, another term used is structural strength.

The stresses developing according to elasticity-theory calculations are dependent on notch depth and notch radius.

Significant experience in plastics is required when it comes to assessing the latter and taking it into consideration in mathematical sizing of components. The theory of elasticity as well as fracture mechanics, which deals with the geometric inhomogeneity of materials, were developed for purely elastic materials. As a result, these considerations can only be applied to thermoplastics to a limited extent.

9.7.2 Welding thermoplastics

The term welding means the permanent joining of thermoplastics by applying heat and pressure, with or without the use of a welding filler. All welding processes take place when the materials in the boundary areas of the surfaces being joined are in a ductile state. That is where the filamentary molecules of the parts being joined and pressed against one another link up and entwine themselves to form a homogeneous material bond.

9.7.2.1 Weldability of material types

Only plastics of the same kind, e.g. PP and PP, and within these types only ones with the same or a similar (adjacent) molecular weight and the same density, can be welded to one another; colour does not have to be taken into account. This means that certain materials can only ever be welded to one another with adequate reliability if they are in the same melt index group or in two adjacent melt index groups.

The melt index groups of the materials can be seen by referring to the names of moulding compounds (PE as per DIN EN ISO 17855-1, PP as per DIN EN ISO 19069-1, PVC-U as per DIN EN ISO 1163-1, fluoropolymers as per DIN EN ISO 12086-2). Rigid polyethylene and plasticised polyethylene cannot be welded to one another. One exception to this rule is, for example, the option of making an adequate join by welding PVC-U to acrylic glass (PMMA).

In the case of PE-HD a distinction is drawn between PE 63, PE 80 and PE 100, which can always be welded to one another. With PP a distinction is made between PP-H, PP-B and PP-R, which can also be welded to one another. For the material PVDF there is no industrial standard or type classification. However, within the market, there are two polymerisation processes with which the raw material PVDF can be manufactured. Although some of the properties vary in detail, this does not apply to welding.

PE-HD

Materials with a melt flow rate MFR (190/5) of 0.2 - 1.7 g/10 min. are suitable for welding. This means that when the materials are warmed the melt viscosity is very similar. This statement is contained in DVS 2207-1 and

has also been confirmed by DVGW (German Gas and Water Association) in an announcement.

PP-H, PP-B, PP-R

Within mass flow rates MFR (230/2,16) 0.2 - 0.6 g/10 min. and MFR (190/5) 0.4 - 1.0 g/10 min. weldability is confirmed. You can read this statement in DVS 2207-11.

PVDF

As already mentioned, there are two different polymerisation processes within the market: emulsion PDF and suspension PVDF. DVS Guideline 2207-15 deals with both heated-tool butt welding and heated-tool socket welding for extruded pipes, fittings and sheets. This guideline describes the suitability of PVDF for welding, irrespective of the manufacturing process. If density is between 1.7 and 1.8 g/cm³ and the melt index MFR (230/5) is between 1.0 and 25 g/10 min., it can be assumed that suitability for welding is unlimited.

ECTFE

Since ECTFE is a relatively new material and consequently the long-term specifications have not yet been completely proven, the DVS Guidelines do not yet contain full details. The long-term specifications for hot-gas string bead welding are listed in DVS 2207-3, Supplement 3.

9.7.2.2 Welding methods

The various welding methods for joining thermoplastic components mainly differ with regard to how heat is introduced to the welding zone.

On an industrial scale the following welding methods have become established:

- Hot-gas string bead welding

- Hot-gas welding with torch separate from filler rod
- Hot-gas extrusion welding
- Heated-tool butt welding
- Heated-tool socket welding
- Electrofusion welding
- Friction welding

For further details reference is made at this point to DVS 2207, which contains an exact description of the various welding methods and also deals with the various types of weld seam.

A short introduction to the topic is also provided by our work.info „Welding“, which you can download from our website at www.simona.de/download.

9.7.2.3 Structural strength

The basis of good weld seam quality is observance of raw-material-related influences, the manufacturing and processing conditions of the semi-finished products and optimal joining zone configuration.

Inner and outer notches and unfavourable wall thickness transitions result in a structural strength that in some cases can be well below actual material strength. Welded joints always constitute an inhomogeneity. Since in most cases weld seams are not machined, there are also irregularities at the surface which can have a negative influence on structural strength.

Figure 58 shows four different corner connections with different configurations. If the corner connections are subjected to a bending load, it is evident that right-angled corner connections are generally much less favourable than rounded corners with joins outside the fillet. Fillets

always allow favourable stress distribution and result in structural strength that is up to 10 times higher than that of conventional right-angled corner connections.

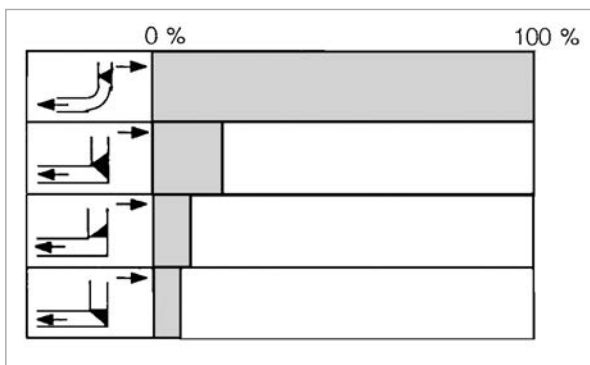

Figure 58: Weld seam strength as a function of weld seam position in corner connections

If a seam is welded on one side only, T-shaped connections have much less favourable behaviour than if a weld is provided on both sides (Figure 59).

Here, too, it is important that there are no notches on the tensile side of the part being subjected to the load. Fillet welds provide a certain amount of curvature. They reduce any excessive stresses so high structural strength is the result.

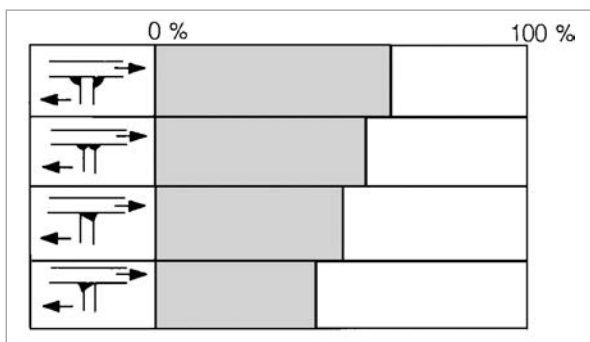

Figure 59: Weld seam strength as a function of weld seam position in T-shaped connections

Figure 60 shows connections that are being exposed to a tensile load. Tensile stresses and shear stresses develop in the seam zone. A machined V-seam provides high structural strength because there is no geometric inhomogeneity whatsoever. In the case of simple butt strap joints (bottom line in Figure 60) there are not only thrust forces and tensile forces but also bending moments in the weld seam. Structural strength is very low. By contrast, a double butt strap joint (top line in Figure 60) permits a uniform distribution of forces. This type of connection has a high level of structural strength. The same applies to cross connections. Maximum weld seam strength is achieved with a double butt strap joint at the top.

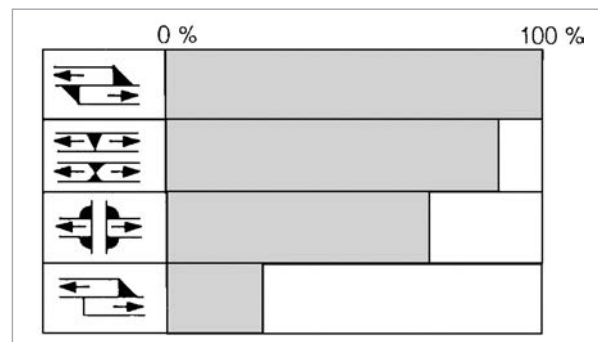

Figure 60: Connecting sheets in one plane

9.7.2.4 Position of weld seams

In the following structural descriptions the findings derived from the previous explanations have been incorporated in practical examples. More detailed information can be found in the welding design principles of DVS 2205-3.

In the case of load-bearing seams or fillet welds the weld seams must be sized in such a way that the required

cross-sections are adequate to transmit forces. Butt joints are preferable. V-seams must be backed at the root. Transitions in the force characteristic are desirable in butt joints with different wall thicknesses (Figure 61).

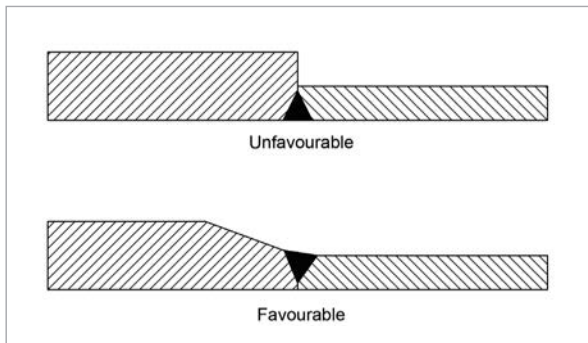

Figure 61: Influence of weld seam when there is a change in cross-section

Weld seams should be taken out of the corner. Fillets at corner connections provide a more favourable force characteristic (Figure 62).

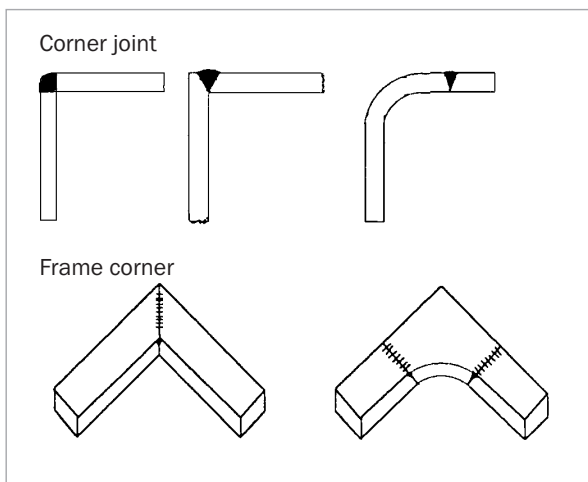

Figure 62: Corner design

Accumulations of weld seams should be avoided. Intersecting seams are not permitted (Figure 63).

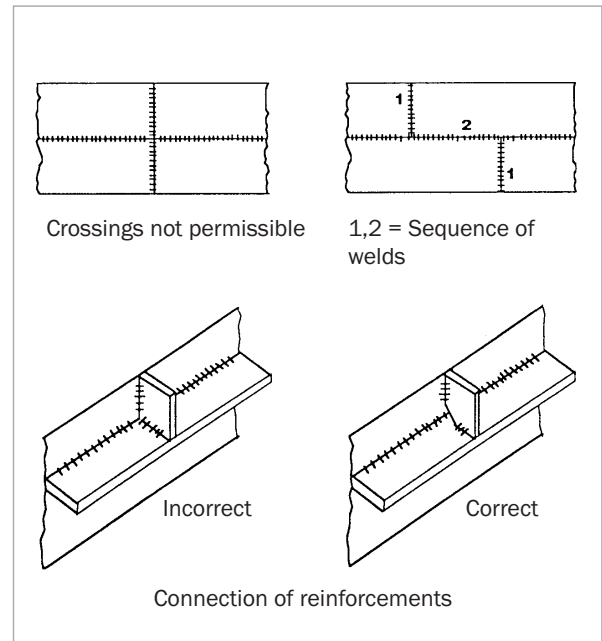

Figure 63: Weld seam accumulations

9.8 Stresses

When welding thermoplastics, various stress states occur depending on the welding method used. Within a weld seam they can be transverse or longitudinal and in the case of relatively thick semi-finished products they can also be perpendicular. These stresses are brought about by local warming in conjunction with non-uniform cooling.

When a material is warmed in the weld seam zone, compressive stresses build up due to a thermal change in length; during the welding process a certain amount of relaxation in stresses has taken place owing to the plastic behaviour of the material. Thermal tensile stresses develop in the subsequent cooling process. Whilst the longitudinal stresses occurring in the weld seam cross-

section are independent of welding method, this is not the case with the transverse stresses also occurring. The level of transverse stresses depends for the most part on whether the sheets being welded are firmly clamped or whether they are free to move.

In hot-gas welding it is the weld seam structure that is responsible for the amount of transverse stress. Owing to the stress relaxation already mentioned, thermal tensile

stresses arise in the starting zone. As welding proceeds, the tensile stress also proceeding develops throughout the entire weld seam zone. On account of stress relaxation the tensile stresses initially decrease in the starting zone of the weld seam but as the welding operation proceeds they increase again. This means that a hot-gas weld seam only has tensile stresses in the longitudinal direction, which explains the bowing in welded sheets (schematic representations: Figures 64 & 65).

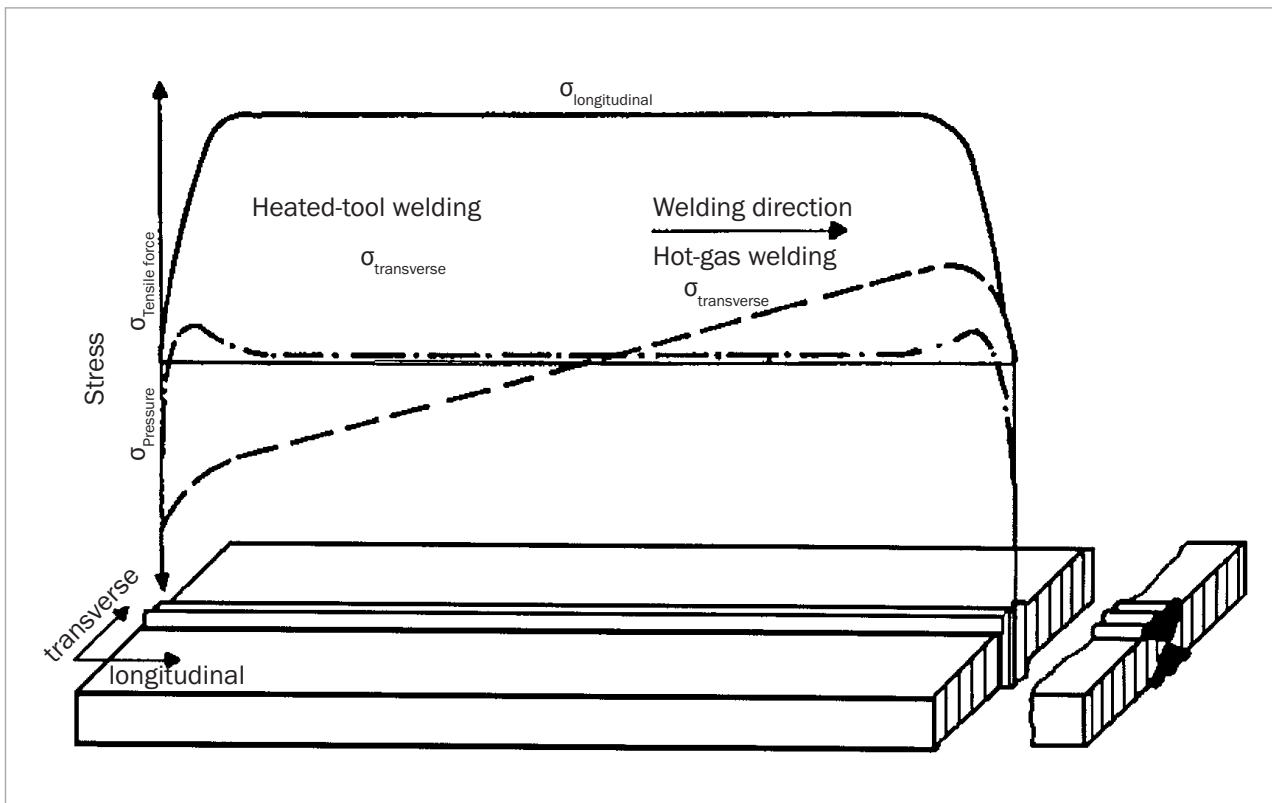

Figure 64: Characteristic of welding stresses over the length of the weld seam during heated-tool butt welding and hot-gas welding (according to Menges)

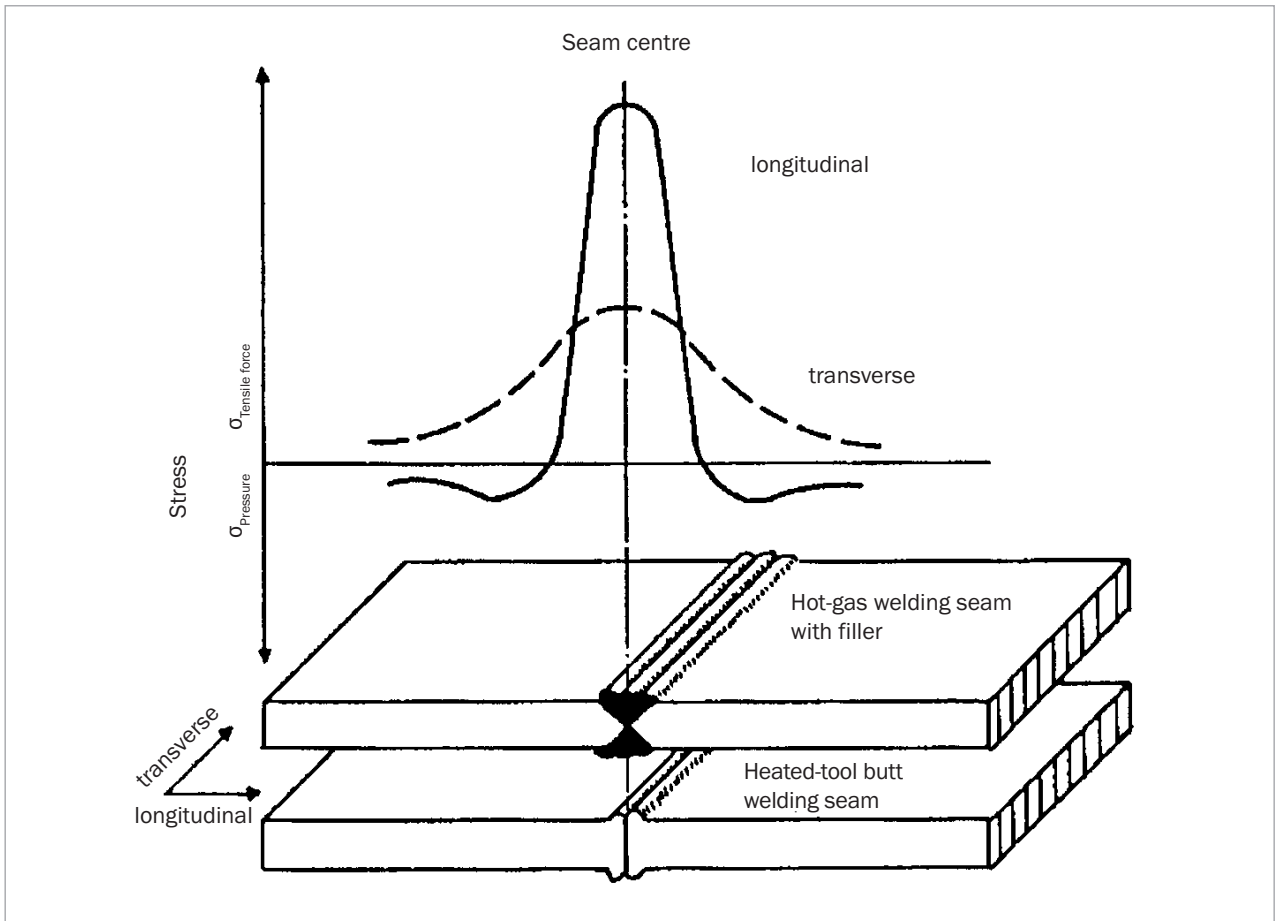

Figure 65: Characteristic of welding stresses above a cut at right angles to the weld seam. The level of transverse stresses in the case of a heated-tool butt welded seam is heavily dependent on the amount and duration of welding pressure (according to Menges)

9.9 Stress cracking

All thermoplastic materials tend more or less towards stress cracking. Especially the amorphous thermoplastics such as polystyrene and PMMA are highly susceptible to stress cracks, which are easy to detect visually on account of the usually transparent structure of these plastics. In the case of dyed, partially crystalline thermoplastics it is often impossible to detect stress cracks, so they can then only be identified by their effects, such as leaks. This phenomenon is also known with metals. There it is referred to as stress crack corrosion, caused by a mechanical load interacting with chemical or electro-chemical processes.

Stress cracks in plastics, on the other hand, are primarily due to physical processes. Therefore, in the case of plastics it is better to use the term stress cracking. Within a crack a substantial stretching of molecules occurs which are anchored to crack edges and counteract the opening of a crack. For the development of stress cracks in plastic parts two triggering factors have to exist, both of which must occur together:

1. The part must be subject to a tensile load or a bending load.
2. A medium that triggers cracks for that material must be present.

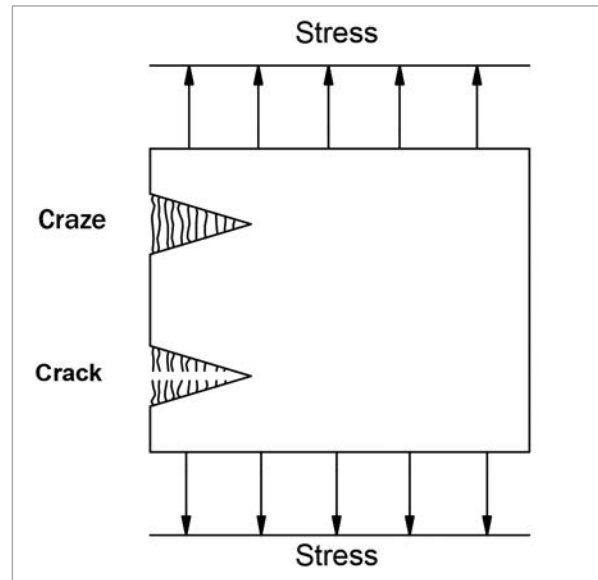

Figure 66: Cracking in a plastic

Three physical effects influence stress cracking in combination with mechanical stresses acting at the surface:

1. Wetting
2. Swelling
3. Diffusion

Owing to the tensile stresses occurring at the surface of a component, „crazes“ (flow zones) develop which do not yet cause any major damage to the material. These are zones of substantially stretched molecular chains whose ends are anchored to amorphous zones and consequently counteract the opening of a crack (Figure 66). The occurrence of crazes does not necessarily mean damage to the material but a weak point in the structure. By means of wetting and diffusion the attacking medium now enters flow zones close to the surface and advances from there to the root of the notch. There a decrease in bonding forces occurs due to physical interaction. This

process has a positive influence on the mobility of the macromolecules. Thus, the external or internal stresses acting in this area build up because of the formation of new flow zones or the growth of existing ones. Crack propagation occurs.

High temperatures generally exacerbate the formation of stress cracks. Swelling and diffusion also tend to speed up crack propagation.

In chemical apparatus construction the stress crack risk usually only arises in combination with medium and mechanical stresses. Semi-finished products not subject to mechanical loads, e.g. sheets or pipes, are not at risk. Joining zones and forming zones in which high residual stresses remain involve a high risk. Especially hot-gas weld seams and cold-bent semi-finished products are often affected by stress cracks due to the high level of inherent stress. Butt-welded seams, hot-bent edges and fold welds, on the other hand, are less critical.

To reduce the risk of stress cracking it is best to perform heat treatment afterwards (annealing), the temperature of which is approx. 20 °C below the crystalline melting point for partially crystalline thermoplastics, but just below glass transition temperature in the case of amorphous ones. The heat treatment times required depend on the wall thickness of the materials.

9.9.1 Inherent stresses

In the beginnings of plastics engineering, sheets made of thermoplastics were only manufactured by the pressing process. With the introduction of extrusion technology it was possible to increase productivity and cost-effective-

ness by means of this continuous process. Nowadays, extruded sheets are of major importance, not only in the PVC sector. Extruded thermoplastics can be manufactured up to wall thicknesses of 50 mm.

The properties of an extruded sheet are different in the direction of extrusion and at right angles to it. This applies both to the chemical properties and to the thermal properties. The stress level of an extruded sheet is also higher than that of a pressed sheet. For this reason a pressed sheet offers advantages wherever a low inherent stress level is necessary in the application or isotropic mechanical properties are required. A low inherent stress level also offers benefits with regard to stress cracking and the dimensional stability of a component after mechanical processing.

	Pressed sheets	Extruded sheets
Inherent stresses	low	existent
Orientations	non-existent	existent
Anisotropy*	non-existent	existent
Recovery at temperatures close to CMR** or glass transition temperature	low	large
Production tolerances	large	small

* Anisotropy = properties independent of load direction

** CMR = crystalline melting range

Table 10: Comparison of properties of pressed sheets and extruded sheets

9.10 Calculation of permissible cold-bending radii

In the manufacture of upright circular tanks the cylindrical surfaces are usually subjected to cold bending and then butt-welded. A cylindrical surface manufactured by this method is prone to tensile stresses on the outside and compressive stresses on the inside. The „neutral layer“, which retains its original length, is located at the middle of the wall cross-section. Owing to the viscoelastic behaviour of thermoplastics, these stresses decline in the course of time as a result of relaxation. The smaller the bending radius and the larger the wall thickness, the higher the critical tensile stress on the outer skin. With the method described below it is possible to quantify the amount of surface-layer stresses by approximation.

To determine the amount of surface-layer strain, the strain is calculated at the level of the neutral layer and surface layer. It is performed with an equation adapted for this purpose:

$$\epsilon_R = \frac{50}{r} \cdot s$$

Surface-layer strain ϵ_R is consequently distributed in proportion to wall thickness s and in inverse proportion to bending radius r . If surface-layer strains of $< 0.2\%$ are determined in this way, it is possible to use Hooke's law to deduce the existing surface-layer stress. Strains of $< 0.2\%$ are in the linear viscoelastic range. Here the stress and strain are proportional to one another. With the modulus of elasticity, the influence exerted by time and temperature is taken into account. For this reason the modulus of elasticity must be inserted in the equation of Hooke's law as a relaxation modulus. Hooke's law is as follows:

$$\sigma = E \cdot \epsilon$$

In the relevant literature, information about the relaxation modulus is difficult to find. The creep modulus can be used as an alternative.

When cold-bending PE it is important to make sure 1% is not exceeded. In the case of materials PP, PVDF and ECTFE, however, more critical standards should be applied. Approximate values for permissible cold-bending radii under various surface-layer strains in relation to wall thickness, which also have to be assumed for tank construction conforming to DVS, can be found in Table 11.

Material	Surface-layer strain ϵ
PE-HD	1.00
PP-H	0.50
PP-B	0.75
PP-R	1.00
PVDF	0.50
PVC-U	0.20
CPVC	0.10

Note: For PE 93, PE 80 and PW 100 the value for PE-HD may be applied.

Table 11: Tolerable surface-layer strain

If owing to design-related requirements smaller bending radii are required, we recommend hot bending (temperature depends on the material).

Generally speaking, surface-layer stress is highest actually during the production of a cold-bent part and then it is relaxed on a time-dependent basis. When cold bending, it is therefore important to always ensure that the deformation rate remains low and constant. Sudden deformations can generate spontaneous stress peaks, which can lead to fracture.

If a constant deformation is forced upon a body, the material is exposed to load, the amount of which decreases more during the first 100 hours than in the period between the 100th hour and the 1,000th hour. For this reason, such components exposed to relaxation should not be subjected to additional loads after load application, e.g. impact load. For PVC-U it is a general rule that in tank construction virtually no cold bending is permissible. Table 12 shows cold-bending radii in relation to surface-layer strain and wall thickness, taking PE 100 as an example.

Surface-layer strain = 1.0 %

Wall thickness s	Permissible bending radius
2 mm	0.100 m
3 mm	0.150 m
4 mm	0.200 m
5 mm	0.255 m
6 mm	0.300 m
8 mm	0.400 m
10 mm	0.500 m
12 mm	0.600 m
15 mm	0.750 m
20 mm	1.00 m
25 mm	1.25 m
30 mm	1.50 m

Table 12: Cold-bending radii for PE 100

9.11 Ageing

Like other materials, plastics are subject to ageing. Ageing is the sum of all irreversible chemical and physical processes in a material during a certain period. Examples include the action of light, heat, moisture and erosion by snow, rain, hail, dust, sand or chemicals. To summarise, these processes are termed external causes

of ageing, whilst thermodynamically unstable states are referred to as internal causes.

In the course of time, chemical influences can lead to a change in the molecular structure or molecular size of the material and in the case of multiphase plastics they can bring about a change in a component of the material and thus alter the property of the material. In the case of physical processes the state of aggregation or the ratio of concentrations of the components in multi-substance systems is altered. On account of erosion or possibly the chalking of pigments, the surface structure of a component changes, which may lead to a reduction in structural strength.

The following physical or technological parameters can be used as ageing indicators:

- Tensile strength
- Tensile strain at break
- Impact strength
- Viscosity
- Colour value
- Surface gloss

9.11.1 Ageing processes due to light

9.11.1.1 Photolysis

In outdoor applications, plastics absorb light depending on wavelengths. Especially ultraviolet fractions of sunlight are able to split primary valence bonds or detach parts of the macromolecule (e.g. HCl detachment in the case of PVC). This process is termed photolysis. Due to the absorption of light and its conversion to heat, the plastic heats up. The resulting temperature increase in the material can be considerable and can trigger thermal degradation (heat ageing).

9.11.1.2 Photo-oxidation

As opposed to photolysis, in which short-wave ultraviolet light is the triggering factor, in photo-oxidation it is the long-wave fractions of light. Oxygen has the property of diffusing into a plastic surface, where it interacts with long-wave light to trigger a complex sequence of radical reactions. This also causes a change in molecular weight. A temperature increase caused by the absorption of light also speeds up photo-oxidation.

9.11.2 Other ageing processes

Influences such as rain, snow, hail, dust and sand cause erosion on the surface of plastic. Dirt on the surface, if it is not removed, counteracts the effect of light. Dust, for example, can form a protective layer against the effect of light (see also oxidic protective layer on aluminium). Through fine hairline cracks on the surface of a plastic part water can penetrate and if it freezes it can cause the cracks to become larger.

Further ageing processes relate to internal processes, which are brought about by a deviation from the thermodynamic equilibrium. In the case of partially crystalline thermoplastics post-crystallisation may possibly take place below the crystalline melting temperature. In this context, the material generally becomes harder and more brittle. In the case of amorphous thermoplastics, too, a change in molecular structure is possible below glass transition temperature due to entropy-elastic effects. This produces an increase in the modulus of elasticity, lower stretchability and a higher level of swellability.

9.11.3 Ageing tests

Changes in mechanical properties, viscosity, gloss or colour can be used as criteria for ageing. The real problem is how to forecast the ageing behaviour of newly developed material formulations. For this purpose equipment was developed (e.g. the QUV tester) with which artificial weathering of plastic test specimens can be conducted. The effects of light, moisture and heat are simulated, as a result of which artificial and accelerated ageing of plastic test specimens can be achieved. However, intensification of influences that trigger ageing modifies the various ageing processes in different ways. For this reason every short-term test should be accompanied by outdoor weathering tests. The more accelerated a test is, the more inferior its correlation with practice under normal circumstances.

Ageing behaviour of the most important SIMONA® thermoplastics

Polyethylene

With regard to ultraviolet radiation unstabilised SIMONA® PE-HD natural and SIMONA® PE 100 natural exhibit a substantial decrease in tensile strength and tensile strain at break after only a few months of outdoor weathering. The behaviour of high-molecular-weight uncoloured PE, e.g. SIMONA® PE 500 or SIMONA® PE 1000, is slightly more favourable. Uncoloured PE is therefore unsuitable for outdoor applications, or only to a limited extent.

Excellent UV stability, and hence favourable ageing behaviour, is provided by SIMONA® PE-HD black, SIMONA® PE 100 black and SIMONA® PE-EL. These materials are stabilised with carbon and there are many years of positive experience with regard to ageing.

Polypropylene

Uncoloured, UV-unstabilised PP types (SIMONA® PP-H natural) behave in a manner similar to that of unstabilised PE. After only a few months of outdoor use there is a noticeable decline in mechanical properties. SIMONA® PP-H AlphaPlus® is particularly heat-stabilised and suitable for applications at temperatures of up to 100 °C. In outdoor applications this material shows changes in colour after only a short period – after approximately one year of outdoor use chalking and a partial decline in mechanical properties are observed.

DVS 2210-1 contains a clause for possible outdoor use of PP: „Where the useful life of a PP pipe outdoors is limited to < 10 years, the formation of an oxide layer under ultraviolet radiation can be compensated by a mathematical addition to wall thickness. Depending on the intensity of ultraviolet radiation and the duration of exposure to ultraviolet light the addition to wall thickness must be specified as $\geq 2\text{mm}$.”

Carbon-stabilised PP types such as SIMONA® PP-EL have favourable ageing behaviour in outdoor applications. Owing to this stabilisation, the strength of unweathered material, however, is lower than in the case of SIMONA® PP-H AlphaPlus® and SIMONA® PP-H natural.

Polyvinyl chloride

Generally, PVC in an unstabilised state also ranks among the moderately resistant plastics. After only one year of weathering, noticeable yellowing and a decrease in impact strength can be detected. The standard material for chemical apparatus construction, SIMONA® PVC-CAW, is only suitable for lengthy outdoor use in the white colour (possibly also in light grey and ivory). All the other colours, e.g. dark grey, absorb sunlight very considerably

and can also heat up beyond the limiting temperature of 60 °C. Consequently, heat distortion temperature in particular constitutes a problem here. For many years of outdoor use SIMONA® PVC-MZ COLOR in particular is to be recommended.

Polyvinylidene fluoride

The material PVDF has excellent ageing resistance. With regard to the uncoloured type SIMONA® PVDF and SIMONA® PVDF-EL there are no reservations about many years of outdoor use.

Ethylene chlorotrifluoroethylene

Like PVDF, ECTFE also belongs to the fluoroplastics, so it has good resistance to ultraviolet radiation. Therefore, SIMONA® ECTFE is also to be recommended for many years of use in outdoor applications.

10 Legal note and advice

Legal note

Upon publication of a new edition all previous editions shall become void. The authoritative version of this publication can be found on our website at www.simona.de.

All information furnished in this publication reflects our current scope of knowledge on the date of publication and is designed to provide details of our products and potential fields of application (errors and omissions excepted, including typographical mistakes). This shall not be deemed as constituting the provision of legally binding guarantees or warranties as to specific properties of the products or their suitability for specific areas of application.

We provide warranty for the faultless quality of our products solely within the framework of our Standard Terms and Conditions of Business and only within the scope specified therein.

We shall assume no liability for the application, utilisation, processing or other use of this information or of our products. Furthermore, we shall assume no liability for any consequences related thereto. The purchaser is obliged to examine the quality and properties of these products; he shall be responsible in full for selecting, applying, utilising and processing said products as well as applying any information relating thereto, which shall also include all consequences associated with such actions. Third-party property rights shall be observed accordingly.

Advice

Our applied technical advice is given according to our best knowledge and is based on the information you have provided and the state of the art known to us at the time such advice is furnished. The advice shall not constitute a guarantee or warranty of specific characteristics or qualities and shall not establish an independent contractual legal relationship.

We shall only be liable for cases of intent or gross negligence. Under no circumstances shall we be held liable for the correctness or completeness of information you have provided or the advisory/consulting services rendered by us on the basis of such information. Any information provided by us shall not release you from your obligation to conduct your own assessments and evaluations.

We reserve the right to update information without notice as part of our continuous research and development programme.

Our sales staff and members of the Technical Service Centre look forward to advising you on all issues relating to the processing and application of semi-finished thermoplastics.

Phone +49 (0) 67 52 14-587

Fax +49 (0) 67 52 14-302

tsc@simona.de

11 List of illustrations, tables and literature

List of illustrations

Figure 1:	Structural model of an amorphous thermoplastic	9
Figure 2:	Structural model of a partially crystalline thermoplastic	9
Figure 3:	Mechanical properties of amorphous thermoplastics	12
Figure 4:	Mechanical properties of partially crystalline thermoplastics	13
Figure 5:	Structural model of a thermoset plastic	14
Figure 6:	Addition reaction of an epoxide	15
Figure 7:	Synthesis scheme of a methylene phenol group as a structural element of a conventional phenolic resin consisting of phenol and formaldehyde	16
Figure 8:	Various schematic representations of polyethylene	17
Figure 9:	High-density PE	17
Figure 10:	Low-density PE	17
Figure 11:	Diagram of the properties of PE-HD in relation to length of molecular chain	18
Figure 12:	Diagram of PP	18
Figure 13:	Diagram of isotactic PP	18
Figure 14:	Diagram of syndiotactic PP	18
Figure 15:	Diagram of atactic PP	19
Figure 16:	Diagram of PVC-U	20
Figure 17:	Diagram of PVDF	21
Figure 18:	Diagram of ECTFE	22
Figure 19:	Diagram of ETFE	23
Figure 20:	Diagram of PFA	23
Figure 21:	Diagram of PETG	24
Figure 22:	Diagram of PLA	24
Figure 23:	Polyamides cross-linked by means of hydrogen bridges; a) Polyamide 4.6; b) Poly(p-phenylene terephthalamide) (PPTA)	25
Figure 24:	Diagram of PMMA	25
Figure 25:	Diagram of PC made of phosgene and bisphenol A	26
Figure 26:	Stress-strain diagram	34
Figure 27:	Principle of the shear test	35
Figure 28:	Mechanical models of the viscoelastic body	35
Figure 29:	Stress relaxation	36
Figure 30:	Creep and creep recovery	36
Figure 31:	Change in specific volume with temperature	38
Figure 32:	Diagram of the stress-strain curve of a partially crystalline thermoplastic	40

Figure 33:	Stress-strain curve with tensile strength σ_s , tensile strength at break σ_b and the associated strains for amorphous thermo-plastics	40
Figure 34:	Short-term modulus of elasticity of SIMONA® thermoplastics in relation to temperature	41
Figure 35:	Diagram of a 3-point and 4-point bending test	42
Figure 36:	Torsion pendulum test	43
Figure 37:	Damped vibration	44
Figure 38:	Ring shear test	45
Figure 39:	Segment shear test	45
Figure 40:	Test arrangement for measuring adhesive tensile strength (test specimen shape A)	46
Figure 41:	Charpy impact bending test	46
Figure 42:	Notched impact strength as a function of temperature	47
Figure 43:	Basic setup of the sand-slurry test	50
Figure 44:	Relative wear of thermoplastics as a function of temperature	51
Figure 45:	Thermal coefficient of linear expansion as a function of temperature for some thermoplastics	54
Figure 46:	Diagram of the SBI test	57
Figure 47:	Capacitor arrangement with polarisation charges; a) without dielectric; b) with dielectric	63
Figure 48:	Creep modulus of PE 100 for 25 years	70
Figure 49:	PE 100 creep curve	72
Figure 50:	Using a creep curve	73
Figure 51:	Isochronous stress-strain diagram of PE 100 for 23°C	74
Figure 52:	Relaxation and retardation sections on an isochronous stress-strain diagram	74
Figure 53:	Stress orientations	77
Figure 54:	Dependence of specific volume on temperature; left: amorphous thermoplastics; right: partially crystalline thermoplastics	78
Figure 55:	Stress characteristic for alternating temperatures	81
Figure 56:	Theoretical analysis of uniform stress distribution	85
Figure 57:	Stress distribution in notched test specimens	85
Figure 58:	Weld seam strength as a function of weld seam position in corner connections	88
Figure 59:	Weld seam strength as a function of weld seam position in T-shaped connections	88
Figure 60:	Connecting sheets in one plane	88
Figure 61:	Influence of weld seam when there is a change in cross-section	89
Figure 62:	Corner design	89

Figure 63:	Weld seam accumulations	89
Figure 64:	Characteristic of welding stresses over the length of the weld seam during heated-tool butt welding and hot-gas welding (according to Menges)	90
Figure 65:	Characteristic of welding stresses above a cut at right angles to the weld seam. The level of transverse stresses in the case of a heated-tool butt welded seam is heavily dependent on the amount and duration of welding pressure (according to Menges)	91
Figure 66:	Cracking in a plastic	92

List of tables

Table 1:	Selection of thermoplastics and the (possible) associated monomers	10
Table 2:	Specifications of PE	17
Table 3:	Molecular weight in g/mol	17
Table 4:	Properties of various thermoplastics	23
Table 5:	Mechanical properties of some thermoplastics	39
Table 6:	Thermal conductivity λ of some materials	52
Table 7:	Mean thermal coefficient of expansion for some materials	54
Table 8:	Assessment of fire behaviour	56
Table 9:	Radiation resistance	69
Table 10:	Comparison of properties of pressed sheets and extruded sheets	93
Table 11:	Tolerable surface-layer strain	94
Table 12:	Cold-bending radii for PE 100	95

Literature

- Wolfgang Retting: Mechanik der Kunststoffe, Hanser Verlag
- Saechtling: Kunststoffhandbuch, Hanser Verlag
- Stephan/Mayinger: Thermodynamik, Springer Verlag
- Michaeli/Brinkmann/Lessenich-Henkys: Kunststoffbauteile werkstoffgerecht konstruieren, Hanser Verlag
- KRV: Kunststoffrohrhandbuch, Vulkan Verlag Essen
- Menges: Werkstoffkunde Kunststoffe, Hanser Verlag
- Ehrenstein: Mit Kunststoffen konstruieren, Hanser Verlag
- Frank/Biederbrink: Kunststoff-Kompendium, Vogel-Verlag
- Lechner, Gehrke, Nordmeier: Makromolekulare Chemie, Birkhäuser Verlag, 3. Auflage, 2003
- DVS Paperback „Fügen von Kunststoffen“

Authors

Konstantin Birt
Mathias Conrad
Dieter Eulitz
Philipp Kuhn
Dr. René Stangenberg
Marco Stallmann

The said authors of the current edition would like to thank all their colleagues who collaborated on previous editions of this document and thus laid the foundation of knowledge for this edition. We would also like to express our thanks in respect of all the works mentioned in the list of references and their publishers for granting permission to use relevant quotations.

SIMONA worldwide

SIMONA AG

Teichweg 16
55606 Kirn
Germany
Phone +49 (0)67 52 14-0
Fax +49 (0)67 52 14-211
mail@simona.de
www.simona.de

PRODUCTION SITES

Plant I
Teichweg 16
55606 Kirn
Germany

Plant II
Sulzbacher Straße 77
55606 Kirn
Germany

Plant I
Gewerbestraße 1 - 2
77975 Ringsheim
Germany

SIMONA Plast-Technik s.r.o.
U Autodílen č.p. 23
43603 Litvínov-Chudeřín
Czech Republic

**SIMONA ENGINEERING PLASTICS
(Guangdong) Co. Ltd.**
No. 368 Jinou Road
High & New Technology Industrial
Development Zone
Jiangmen, Guangdong
China 529000

SIMONA AMERICA INC.
101 Power Boulevard
Archbald, PA 18403
USA

**Boltaron Inc.
A SIMONA Company**
1 General Street
Newcomerstown, OH 43832
USA

**SIMONA IBERICA
SEMIELABORADOS S.L.**
Doctor Josep Castells, 26 - 30
Polígono Industrial Fonollar
08830 Sant Boi de Llobregat
Spain
Phone +34 93 635 4103
Fax +34 93 630 8890
mail@simona-es.com
www.simona-es.com

SIMONA Plast-Technik s.r.o.
Paříkova 910/11a
19000 Praha 9 - Vysočany
Czech Republic
Phone +420 236 160 701
Fax +420 476 767 313
mail@simona-cz.com
www.simona-cz.com

SIMONA POLSKA Sp. z o.o.
ul. Wrocławska 36
Wojkowice k / Wrocławia
55-020 Żórawina
Poland
Phone +48 (0) 71 3 52 80 20
Fax +48 (0) 71 3 52 81 40
mail@simona-pl.com
www.simona-pl.com

SALES OFFICES

SIMONA S.A.S. FRANCE
43, avenue de l'Europe
95330 Domont
France
Phone +33 (0) 1 39 35 49 49
Fax +33 (0) 1 39 91 05 58
mail@simona-fr.com
www.simona-fr.com

SIMONA UK LIMITED
Telford Drive
Brookmead Industrial Park
Stafford ST16 3ST
Great Britain
Phone +44 (0) 1785 22 2444
Fax +44 (0) 1785 22 2080
mail@simona-uk.com
www.simona-uk.com

SIMONA AG SWITZERLAND
Industriezone
Bäumlimattstrasse 16
4313 Möhlin
Switzerland
Phone +41 (0) 61 8 559 070
Fax +41 (0) 61 8 559 075
mail@simona-ch.com
www.simona-ch.com

**SIMONA S.r.l. SOCIETÀ
UNIPERSONALE**
Via Volontari del Sangue 54a
20093 Cologno Monzese (MI)
Italy
Phone +39 02 2 50 85 1
Fax +39 02 2 50 85 20
commerciale@simona-it.com
www.simona-it.com

**SIMONA IBERICA
SEMIELABORADOS S.L.**
Doctor Josep Castells, 26 - 30
Polígono Industrial Fonollar
08830 Sant Boi de Llobregat
Spain
Phone +34 93 635 4103
Fax +34 93 630 8890
mail@simona-es.com
www.simona-es.com

SIMONA Plast-Technik s.r.o.
Paříkova 910/11a
19000 Praha 9 - Vysočany
Czech Republic
Phone +420 236 160 701
Fax +420 476 767 313
mail@simona-cz.com
www.simona-cz.com

SIMONA POLSKA Sp. z o.o.
ul. Wrocławska 36
Wojkowice k / Wrocławia
55-020 Żórawina
Poland
Phone +48 (0) 71 3 52 80 20
Fax +48 (0) 71 3 52 81 40
mail@simona-pl.com
www.simona-pl.com

000 "SIMONA RUS"

Projektiruemy proezd No. 4062,
d. 6, str. 16
BC PORTPLAZA
115432 Moscow
Russian Federation
Phone +7 (499) 683 00 41
Fax +7 (499) 683 00 42
mail@simona-ru.com
www.simona-ru.com

SIMONA FAR EAST LIMITED

Room 501, 5/F
CCT Telecom Building
11 Wo Shing Street
Fo Tan, Hong Kong
China
Phone +852 29 47 0193
Fax +852 29 47 0198
sales@simona-hk.com
www.simona-cn.com

SIMONA ENGINEERING PLASTICS TRADING (Shanghai) Co. Ltd.

Room,5, 19/F, Block B
Hongqiao Nanfeng Town
No. 100 Zunyi Road
Changning District
Shanghai
China 200051
Phone +86 21 6267 0881
Fax +86 21 6267 0885
shanghai@simona-cn.com
www.simona-cn.com

SIMONA INDIA PRIVATE LIMITED

Star Hub, Unit No. 204,
2nd Floor, Building No. 1,
Sahar Road, Andheri East,
Mumbai 400099
India
Phone +91 (0) 22 66 197 100
Fax +91 (0) 22 66 197 105

SIMONA AMERICA INC.

101 Power Boulevard
Archbald, PA 18403
USA
Phone +1 866 501 2992
Fax +1 800 522 4857
mail@simona-america.com
www.simona-america.com

Boltaron Inc. A SIMONA Company

1 General Street
Newcomerstown, OH 43832
USA
Phone +1 800 342 7444
Fax +1 740 498 5448
info@boltaron.com
www.boltaron.com



SIMONA AG

Teichweg 16
55606 Kirn
Germany

Phone +49 (0) 67 52 14-0
Fax +49 (0) 67 52 14-211
mail@simona.de
www.simona.de